

**AN ANALYSIS OF A REMOTE-VIEWING
EXPERIMENT OF URDF-3**

#9

SG1J



ANALYSIS BY:

TYPED BY:

DECEMBER 4, 1975

SUMMARY

SG1J

The remote-viewing experiment of URDF-3 by [REDACTED] proved to be unsuccessful. This conclusion was reached only after a careful review of the tape recordings, tape transcripts, and sketches that were generated during the four-day experiment.

SG1J

During the first day's session, [REDACTED]

- 1) accurately described the location and type of target (that information had been given to him by the experimenters) but failed on the layout and types of buildings,
- 2) saw a gantry crane for heavy lifting,
- 3) tended to spend too much time on specifics only to say, "I'll come back to that," but seldom did, and
- 4) successfully evaded drawing a perimeter of the area even though he was asked to do this twice.

Therefore, nothing positive to validate remote viewing resulted from the first day's session.

SG1J

[REDACTED] was contacted by phone that evening by one of the experimenters and was told to concentrate on the crane and its relationship to the dominant three-story building (Building 1) that he had seen during that day's session. He was also told that they wanted a drawing of the perimeter fence.

SG1J

On the second day, [REDACTED] supplied the most positive evidence yet for the remote-viewing experiment with his sketch of the rail-mounted gantry crane. It seems inconceivable to imagine how he could have drawn such a likeness to the actual crane at URDF-3 unless:

- 1) he actually saw it through remote viewing, or
- 2) he was informed of what to draw by someone knowledgeable of URDF-3.

The second possibility is mentioned only because the experiment was not controlled to discount the possibility that ██████ could talk to other people.

SG1J

█████ commented that he was seeing a lot of things this second day that he hadn't seen the previous day. In fact, he mentioned seeing several landmark-type objects that simply did not exist at URDF-3. One explanation of this discrepancy could be that if he mentioned enough specific objects, he would surely hit on one object that is actually present. This could explain the inconsistency between:

- 1) his most positive evidence of the experiment - a sketch of a rail-mounted gantry crane, and
- 2) the large number of objects he sees that, in reality, are simply not present at URDF-3.

SG1J

This discrepancy between what ██████ sees and what is really there certainly would make it difficult for the eventual user of his remote-viewing data since he would not know how to differentiate the fact from the fiction. At this stage of the experiment, the data is inconclusive to validate ██████'s capability of remote viewing.

SG1J

█████ was shown a sketch of a perspective of the Operations Area at URDF-3 on the third day and was told that this was a sketch of the actual target. ██████ said he recognized the area but claimed that only one of the four headframes was present now. That was wrong, but his most damaging statements had to do with his interpretation of Building 1 (the underground building) at URDF-3. With the sketch as a reference, he "saw" the four main surface protrusions of Building 1 as four separate above-ground buildings sitting atop a concrete apron. He was asked specifically whether these four buildings he saw might really be the surface elements of an underground building. He failed either to pick up the lead or to remotely view correctly because he said, "No, that's a concrete apron, and there's nothing subterranean right in that particular area." This statement was his most negative evidence yet and tends to discredit his ability to remotely view URDF-3.

SG1J

[REDACTED]'s comments on the fourth day were very specific regarding his concept of the overall operation at URDF-3, however no new evidence (that could be checked) was disclosed toward establishing validity for his remote-viewing capability.

SG1J After careful analysis of all the data presented, I have concluded that [REDACTED] remote-viewing experiment of URDF-3 was unsuccessful.

~~CONFIDENTIAL~~

INTRODUCTION

I was asked to analyze and ~~to~~ judge the validity of the remote-viewing experiment performed on URDF-3 by [REDACTED]. The data to be analyzed included two cassette tapes covering the first two days, 79 pages of transcribed tapes regarding the third and fourth days, and 30 sketches; I also reviewed the July 5, 1974 of URDF-3.

I am quite familiar with the chronology and layout of URDF-3, as well as the surrounding terrain and technical areas within 40 miles. I tried to keep an open mind while performing this analysis, but if I had any bias at all, it was that I wanted to believe remote viewing could help us establish the true purpose of URDF-3.

Throughout this analysis, I paid particular attention to all information about URDF-3 that was supplied to [REDACTED]. This was necessary in order to evaluate his originality in remote viewing. This study was done in four segments corresponding to the four days of the experiment. Judgment of the progress and validity of the experiment was evaluated at the end of each day.

FIRST DAY

The experiment started at 11 a.m. on July 9, 1974 at Stanford Research Institute (SRI). The experimenters (Russ Targ and Hal Puthoff) told [REDACTED] that the target was a geographical target selected from the Times of London World Atlas. The coordinates of the target were given as 50°9'59"N and 78°22'22"E; [REDACTED] wrote these coordinates down. It was emphasized that this was a "real target" as opposed to a sample target. Using several maps, the experimenters showed [REDACTED] the target location at 60 miles WSW of Semipalatinsk. The target was described as a scientific military research and test area. To help orient [REDACTED] he was told that the target was 25 to 30 miles SW of "this river," presumably labeled correctly on the maps as the Irtysh River. [REDACTED] was told to start with a view of the general area as seen from 50,000 ft. and get the layout of any complexes or buildings, or whatever.

~~CONFIDENTIAL~~

The business about the pool is not so clear cut. There
is a reservoir for emergency waste dumping a few hundred meters
away.

SG1J

When the coordinates were given, [REDACTED] said he was getting a picture that they (the Soviets) have done a lot of rocket launching and recovery out of that area. As he starts viewing, he says it's dark over there at the present time, quite a cloud cover, and a full moon. He immediately sees the river and heads SW from the river to the institute (as he calls it). He says the area he's looking at has low one-story buildings that are partially dug into the ground giving the effect (as seen at ground level) of very short, squatty buildings, whereas they are actually fairly roomy on the inside. This description could very well describe a first look at the Operations Area at URDF-3.

He then finds that he is looking at "a guy in a very peculiar type of helmet." He tends to get bogged down in the specifics of the purpose of this helmet and shifts his attention to look at the cosmonauts (that were currently in orbit) to compare helmets. He says they (the Soviets) are running some tests on some equipment that currently has to do with their space program. Then he backs off from this specific subject and says, "I'll look around and come back to that" - but he never does.

SG1J

[REDACTED] was then asked to describe the general terrain and perhaps the building layout. He drew a sketch (Fig. 1) in which he correctly identifies the complex as being about 30 miles south of the Irtysh River (this information had been given to him earlier). However, he incorrectly says the road from the river passes through a gorge. The layout of the buildings and area they cover as shown in his sketch are incorrect for URDF-3. Although there are some antennas at URDF-3, none are as tall as the 500-ft. antenna he described.

He pondered over the dimensions of the outdoor pool he saw because "that's in meters - they have it." He then translates it to feet (60' x 150'). He said they use the pool for underwater testing and orientation studies but in reality there is no outdoor pool at URDF-3.

In Fig. 2, he drew a military complex three-eighths of a mile NE of the scientific complex shown in Fig. 1. Actually there is a military complex at URDF-3, located about 2 1/2 miles NW of the Operations Area, but this data was

31

MIL COMPLEX

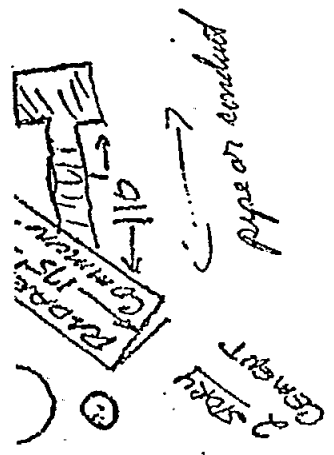

Communication Line Building

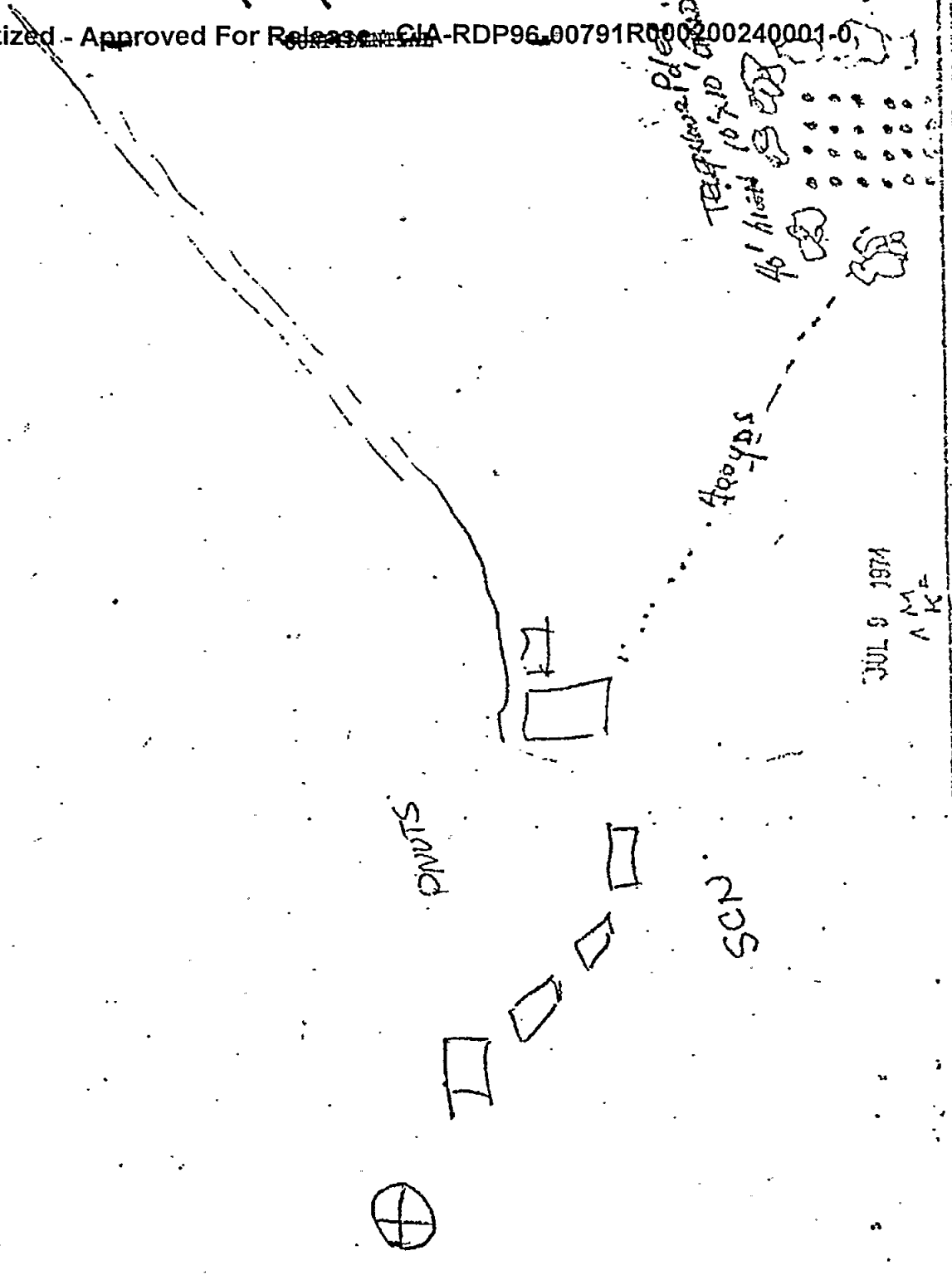

JUL 9 1974
A M
A K E

CONFIDENTIAL

Figure 2

(B)

given to him earlier when the target was described as a scientific military research and test area. He said the military complex looked like it had been there for two to three years, when in fact it's been there for over a decade.

Also in Fig. 2, he described a radar/communications building north of the scientific complex. The description of the building and its location relative to the military complex fits the description of the probable laboratory-administration building located about 2 1/2 miles northwest of the Operations Area at URDF-3. When he is specific about what he sees inside the building, one of the experimenters asks whether one of the specifics he mentioned might well be something else. He takes another look and changes his mind saying, "You may be right," giving the impression that he could be led to see what the experimenter suggests. The experimenter quickly informed [REDACTED] that "we really don't know what this thing is," and [REDACTED] replies with, "I'll come back to that," but again never does.

SG1J

[REDACTED] saw an array of telephone poles about 400 yards SE of the scientific complex (see Fig. 2), but there is no such array of poles at or near URDF-3.

He was then asked to go up to 50,000 ft. to look again and describe the layout. Centering himself over the scientific complex, he scanned in a clockwise direction; the view he saw is sketched in Fig. 3. Nothing in this figure is correct except that the area is arid and has low hills to the south. Specifically, he is incorrect in his locations of a small village, an airstrip, a cluster of pine trees, and a city 60 miles to the SW. There is, however, an airfield at the Main Support Complex 30 miles north of URDF-3.

SG1J

[REDACTED] was asked if he saw a railroad anywhere. The closest railroad to the target that he could see was about 60 miles north running roughly NW and SE and he didn't see any spur tracks in a direction toward the target. In reality, there is a railway in the Main Support Complex (about 30 miles north of URDF-3) with a railway spur under construction down to URDF-3. There is also grading for a railway spur near the military complex at URDF-3.

JUL 8 1974
AM
KZ

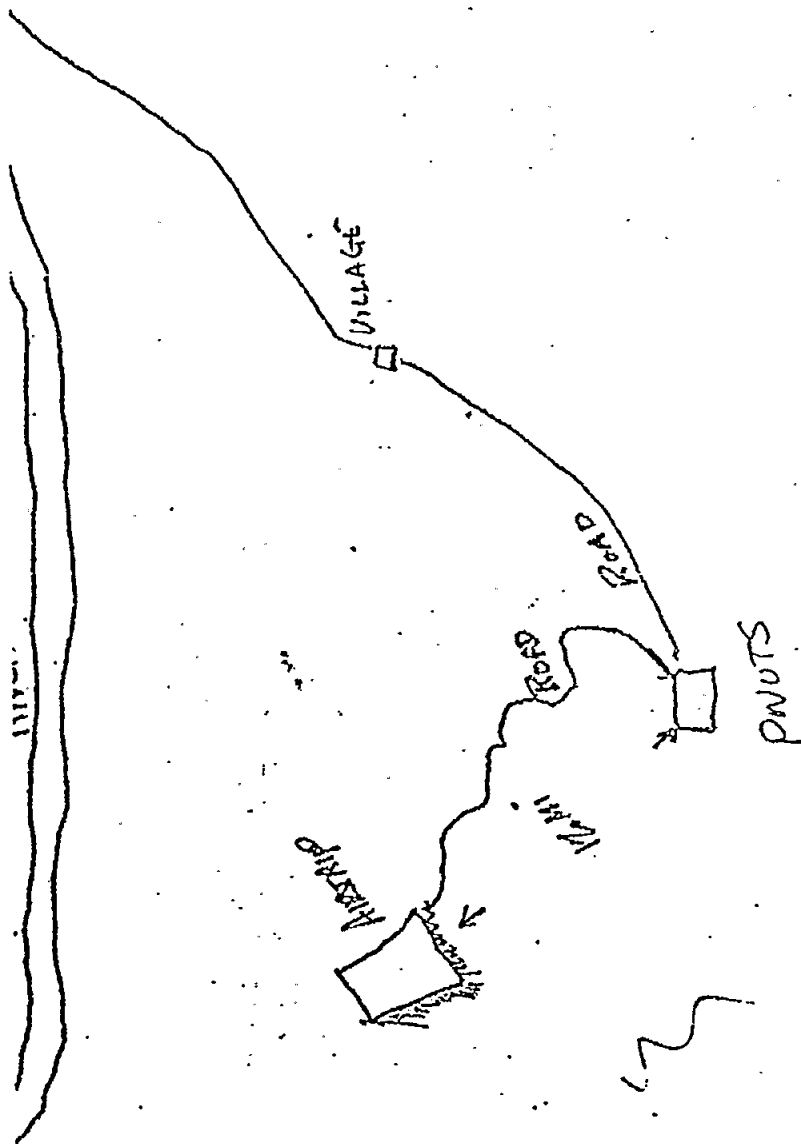

Low hills

ARID

14.71 N 65 E

COM

SAVING CITY

SG1J

██████ became specific in looking at a scope trace at the airstrip and claimed it made him nauseated. At this time the experimenters and ██████ decided to have lunch so ██████ said he would come back to this later, but as he randomly elevated himself, he noted the area was under high security and had a cyclone fence. He could read the troop markings and buttons on a Colonel and then said he could come back to the security and military designations. In reality, the Operations Area of URDF-3 has 4 security fences, not just one cyclone fence. They stopped for lunch at about 12:14 p.m.

SG1J

After lunch, at 2:22 p.m., ██████ picks up with the scope trace at the airstrip. He concludes that the trace indicates the pulse of someone who is nauseated - that's why it caused nausea in him.

He was asked to indicate again where the telephone poles were and to map out the perimeter of the area. He drew in the telephone-pole grid with a circle of trees around the grid (see Fig. 2). There is no telephone-pole grid like this at or near URDF-3.

Upon spotting several low-boy trucks and a gantry crane (for very heavy lifting) in the vehicle area (Fig. 1), ██████ was asked if he could tell where they took the heavy things from the low-boy trucks. This question led him to a look at the area near Building 1 in Fig. 1. He saw a sign in front of the building that said something to do with Zone 4. He said he would get back to that but never did.

When describing Building 1, he said it had three stories above-ground plus a basement with meteorological equipment on the flat roof and then looked inside the building at the top floor. He started to get too specific as to what he saw inside the building and was reminded that the type of thing the experimenters could best check him on was the outside appearance of the buildings. They asked him the dimensions of Building 1 and he had a very difficult time establishing them when he finally settled on 80' x 160'. He then described the other buildings in the scientific complex. He said Building 1 was the dominant building due to its height and central location; everything seemed to pivot off of it. There is no building at URDF-3 that matches the above description of Building 1.

They decided to stop the experiment for the day but asked [REDACTED] to look at the target at different intervals that evening. (Due to the difference in time, all of his viewing during this formalized part of the experiment - on this first day - had been at nighttime locally at URDF-3).

SG1J

[REDACTED] said he was beginning to labor anyway and, "if you start laboring at it, you start mocking-up things." He was then reminded that he was going to draw a perimeter, or would he rather save that for tomorrow. He said he would rather save that since he's starting to labor a bit. It was unfortunate that they didn't pursue the perimeter earlier in the day because it certainly has a unique shape. They quit at 3 p.m.

Summary of the First Day

The controlled session taped at SRI lasted a total of about 1 hour and 52 minutes. It consisted of the experimenters defining the target as a "real target" as opposed to a sample target. With the use of several maps, [REDACTED] was given coordinates of the target and told that it was a scientific military research and test area about 25 to 30 miles SW of the Irtys River.

SG1J

When the coordinates were given, [REDACTED] immediately biased his thinking that this area was related to the Soviets' space-launching and recovery areas. Since this is not true, he may have inadvertently and unknowingly biased himself into an incorrect target relationship.

SG1J

[REDACTED] described the target as a military and scientific complex about 30 miles SW of the Irtys River but there is nothing in this description that wasn't already given to him. He then gives what is almost a perfect description of someone's first look at the Operations Area of URDF-3. He describes it as low one-story buildings that are partially dug into the ground giving the effect (as seen at ground level) of very short, squatty buildings, whereas they are actually fairly roomy on the inside. Unfortunately, as he later describes the specifics of buildings in the scientific complex, he never again mentions earth-covering of partially-buried buildings. It seemed he had the perfect description of URDF-3, but never came back to that again. In fact, his later

description of the most dominant building (a large three-story building) doesn't match any building at URDF-3.

SG1J

tends to get bogged down in specifics and then says something like, "I'll come back to that," but seldom does. He said the military complex looks like it's been there for two to three years when in fact it's been there for over a decade. At one point when describing the specifics of the "radar/communications building," he demonstrates that he could possibly be led to see what the experimenter wants him to see.

He sees some landmark-type items that simply don't appear at or near URDF-3. They are:

- 1) the road from the river to the target area passes through a gorge,
- 2) a 500-ft. tall antenna,
- 3) an outdoor pool (60' x 150'),
- 4) an array of telephone poles surrounded by trees about 500 yards SE of the scientific complex,
- 5) an airstrip on a plateau 12 miles NW of URDF-3,
- 6) a small village NE of URDF-3,
- 7) a city 60 miles SW of URDF-3,
- 8) a cluster of pine trees west of URDF-3, and
- 9) a three-story building (with a basement) as the dominant building in the scientific complex.

It doesn't seem fair to grade him on landmark-type objects he failed to see at the target because his attention may not have been directed on them. However, it does seem fair to question the existence of those objects he claims to have seen.

The most positive evidence of valid remote viewing for the first day (1 hour and 52 minutes) was his initial view of the target as "low one-story buildings that are partially dug into the ground..." Unfortunately, he never considered that description again. The only other piece of positive evidence that day was his view of a gallery of art for heavy tanks.

SG1J

To summarize the first day's session, [REDACTED] accurately described the location and type of target (but that was given) but failed on the layout and type of buildings. He tended to spend too much time on specifics only to say, "I'll come back to that," but seldom did. He successfully evaded drawing a perimeter of the area even though he was asked to do this twice. This was unfortunate because the shape of the perimeter is unique. My conclusion is that nothing positive to validate remote viewing resulted from this first day's session.

Additional Contact on the First Day

Hal Puthoff talked to [REDACTED] by telephone that evening at 5:25 p.m. to give him further instructions for his scanning that night. He was told that there were some specific areas he had mentioned that the experimenters were most interested in. Specifically he was asked "for an exact, as possible, drawing of the crane (that was in the rear of Building 1) and exactly what its relationship is to Building 1." Further, they wanted to know "anything about Building 1 in relation to the surrounding buildings, like whatever forms of connection or communication or transportation that exists between Building 1 (the main building) and the ones that are nearby." They especially wanted "as much detail as possible on the gantry crane and its relation to Building 1."

He was told that the second thing they were most interested in was the security fence around the perimeter. They wanted any detail on that - even a drawing of exactly what the fence looked like. It was emphasized that the crane was really top priority, especially what it looked like in relation to the main building (Building 1).

SECOND DAY

The remote-viewing experiment resumed at 11 a.m. on July 10, 1974. It was mentioned that the previous night [REDACTED] had turned in drawings of a fence and a crane. [REDACTED] first comments had to do with an observation of the immense size of the gantry crane. He said he didn't realize how large the gantry crane was until he saw a man walking by one of the crane wheels. Assuming the height of the man as 6 ft., he realized that the dimensional data he had derived the day before was underestimated by at least a factor of 3.

Sanitized - Approved For Release : CIA-RDP96-00791R000200240001-0

He commented on the security fence as being electrified, but never mentioned the unique shape of the perimeter fence or the fact that there are really four perimeter fences at URDF-3. Figure 4 is his sketch of a small section of the fence.

██████████ was again told that the experimenters wanted more information on exactly what the relationship was between the crane and the major building (Building 1); specifically, how did the crane interact with Building 1 or anything surrounding the building. ██████████ said the gantry crane interacted with Building 1, the outdoor pool and the telephone pole array. He drew a sketch showing the relative locations of buildings as he saw them that day (Fig. 5). He said the crane was so heavy that it left tracks in the ground and that, "the crane tracks go to the building and where this sunken building is." Unfortunately, the experimenters did not ask him to identify the "sunken building." This was important because in reality the gantry crane at URDF-3 operates on rails over a sunken building (designated as Building 1 by NPIC).

SG1J

As ██████████ continued to look at the area, he said, "I'm seeing a lot of things today I didn't see yesterday... I can see some very heavy... looks like railroad track, but they're spread much too wide so it looks like a riding gantry." That description compares quite closely with one of the most distinctive observables at URDF-3 - the gantry crane that operates on rails over the three-story underground building (Building 1 at URDF-3).

However, his description of the interaction between the crane and Building 1 is incorrect. He describes two gantry cranes that enter into his above-ground Building 1 whereas the single gantry crane at URDF-3 operates on rails above the underground Building 1. His description of this building is also wrong in several respects as compared to the actual Building 1 at URDF-3. The major difference is that Building 1 at URDF-3 is an underground building rather than above ground as ██████████ described it. He was asked, "Are there any windows in the building at all?" At this time, he realizes for the first time that the building is actually five-stories tall rather than three-stories as he had originally thought. He saw windows on the second, third and fourth stories on the north side of the building and said there were no windows on the other three sides. The session

Sanitized - Approved For Release : CIA-RDP96-00791R000200240001-0

~~CONFIDENTIAL~~

9

Sanitized - Approved For Release : CIA-RDP96-00791R000200240001-0

CONFIDENTIAL

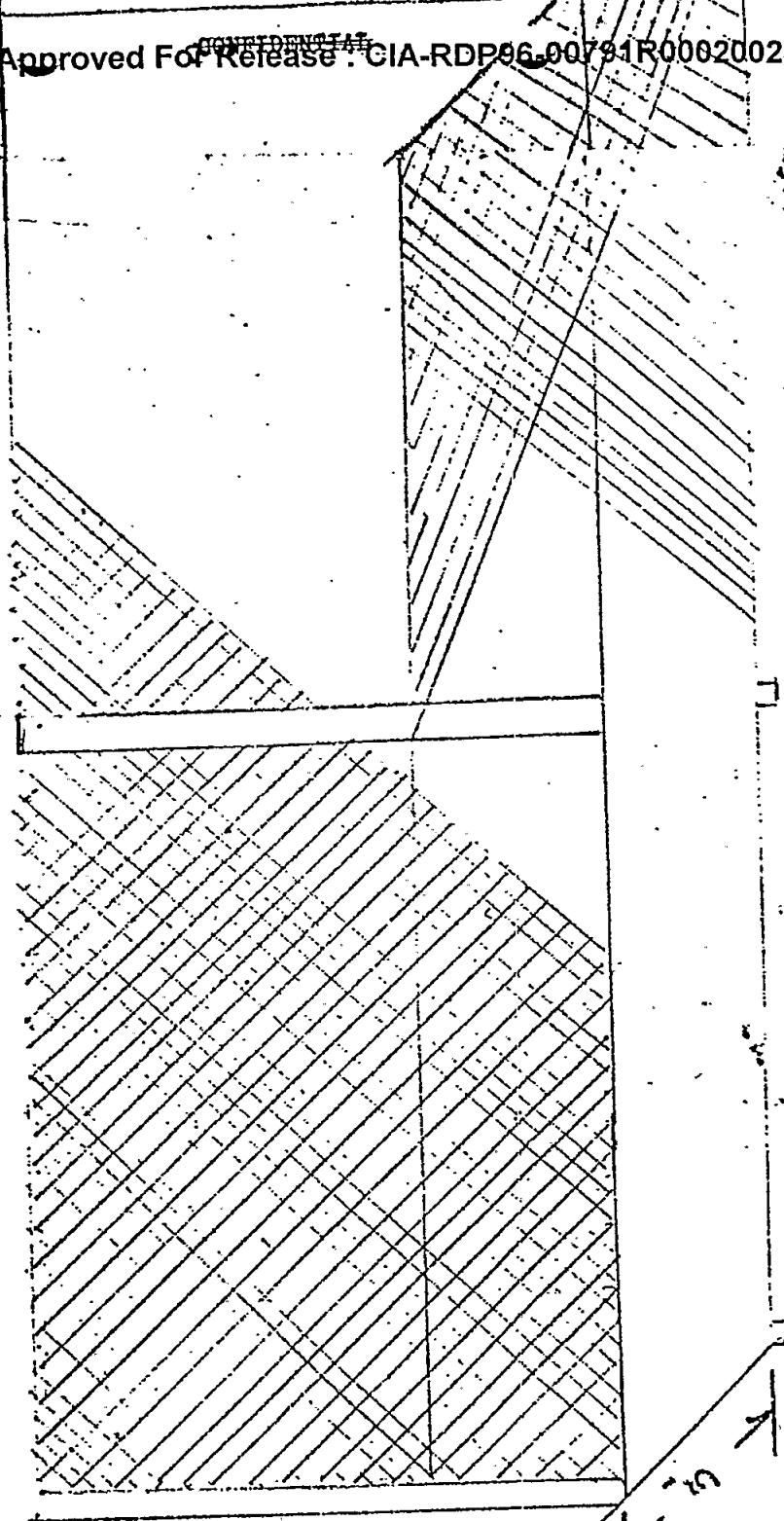

OUTSIDE

*Security
and file*

Sanitized - Approved For Release : CIA-RDP96-00791R000200240001-0

CONFIDENTIAL

CONFIDENTIAL

JUL 10 1954

DAY
KZ

Telephone pole grid

Military Complex

MIL

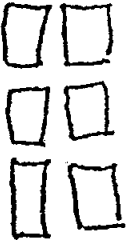

His north

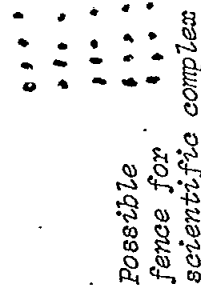
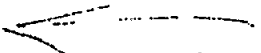

Possible fence for scientific complex

PNUTS

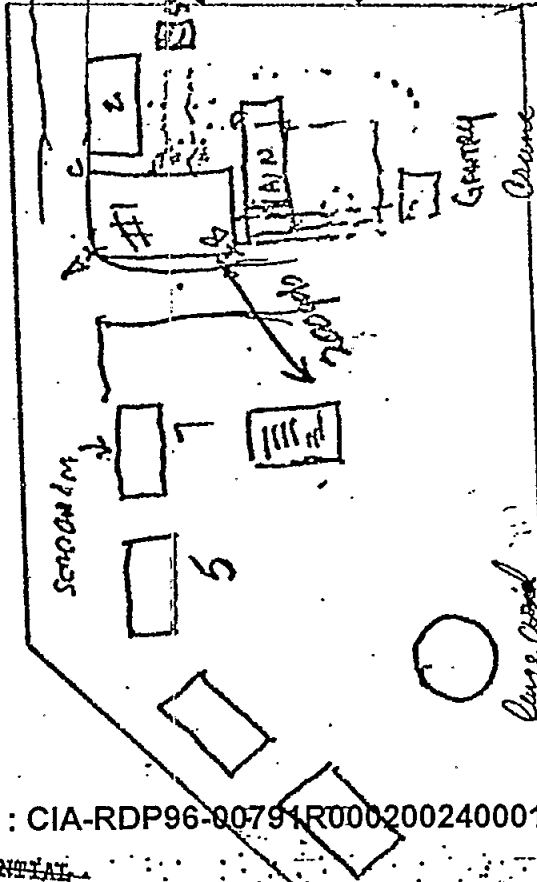

Communications Center

Large coil antenna

Refined drawing of area

CONFIDENTIAL

SG1J

continued with discussions of the length of the gantry rails. [REDACTED] saw welding operations taking place south of Building 1 and also saw an electrical substation east of the building (see Fig. 5). In reality there is no substation near the gantry crane or Building 1 at URDF-3. The session ended at noon.

The session resumed at 3:01 p.m. with what appears to be a telephone conversation between [REDACTED] and one of the experimenters. Although it's possible to hear only the experimenter's side of the conversation, the discussion appeared to be related to the dimensions of the gantry crane. [REDACTED] had said earlier that day that:

- 1) the distance between the rails was about 50 ft.,
- 2) the height of Building 1 was about 50 ft.,
- 3) the height of the gantry crane was about 150 ft.,
and
- 4) the crane ran on the rails that entered into
Building 1.

The above dimensions lead to a discrepancy in dimensions because the gantry crane is too tall (150 ft.) to enter the 50 ft.-tall Building 1. This discrepancy is resolved by [REDACTED] telling the experimenters that the tall gantry crane does not enter Building 1 but that there are two shorter gantry cranes inside Building 1 that also run on the 50 ft.-wide rails - one running east-west on rails and one running north-south to meet the tall gantry crane outside the building on the same rail. This complicated relationship of three gantry cranes does not exist at URDF-3.

SG1J

[REDACTED] then contacted by phone again and asked to scan the area across the road west of Building 1 (see Fig. 5). He is told that in that region there's something else which is on the order of being as large or as unique as the crane. (The experimenter is obviously trying to see if [REDACTED] can see the four headframes that exist at URDF-3). Note SG1J there is an azimuthal shift of 90° in comparing the north-south motion of [REDACTED] tall rail-mounted gantry crane as opposed to the actual east-west motion of the rail-mounted gantry crane at URDF-3. For the time being, if one accepts this rotation of 90°, the

CONFIDENTIAL
SG1J

experimenter was correct in asking [REDACTED] to look in the region west of Building 1 as shown in Fig. 5. [REDACTED] was also reminded at the end of this phone conversation to continue working on a picture (sketch) of the tall rail-mounted crane that runs up to Building 1.

The ~~SG1J~~ resumes with yet another telephone conversation between Russ Targ and [REDACTED] with only the voice of Russ Targ being heard. [REDACTED] apparently reported that he saw a dome-shaped building (about 55' tall x 160' diameter) with its center located about 200 ft. west of the SW corner of Building 1. He also saw a 65-to-75 ft.-tall cement silo-like building south of the dome-shaped building that consisted of three 25 ft.-diameter vertical silos tangent to each other (see Fig. 6 for their relative locations). He confirmed that the swimming pool was west of both Building 1 and the silo-like building.

Russ Targ then concluded the phone conversation with a request for a sketch of the crane that runs on rails; specifically, "What does the crane look like when it's outside of Building 1?" Since [REDACTED] had seen two types of gantry cranes (one about 150 ft. tall and the other about 50 ft. tall), he sketched both of them (see Figs. 7 and 8).

Discussion of Sketches Drawn by [REDACTED] on the Second Day

The detail shown in Fig. 7, the sketch of the taller gantry crane, is remarkably close in detail to the actual gantry crane at URDF-3. [REDACTED]'s sketch provides the most positive evidence yet to support the validity of [REDACTED]'s remote viewing of URDF-3.

Figures 9 and 10 illustrate the cement silo-like building and the dome-shaped building. Figure 6 shows their relative locations to Building 1; however, there is nothing at URDF-3 that looks like the dome-shaped building or the silo-like building. In Fig. 6, these buildings are shown in the general location where, at URDF-3, a partially earth-covered tank and tall cylindrical-shaped tanks or towers appear. The swimming pool (in Fig. 6) is in the general location of the headframes at URDF-3.

FORM 10 1974
SECURITY INFORMATION

CONFIDENTIAL

Sanitized - Approved For Release : CIA-RDP96-00791R000200240001-0

His NORTH
→ Z

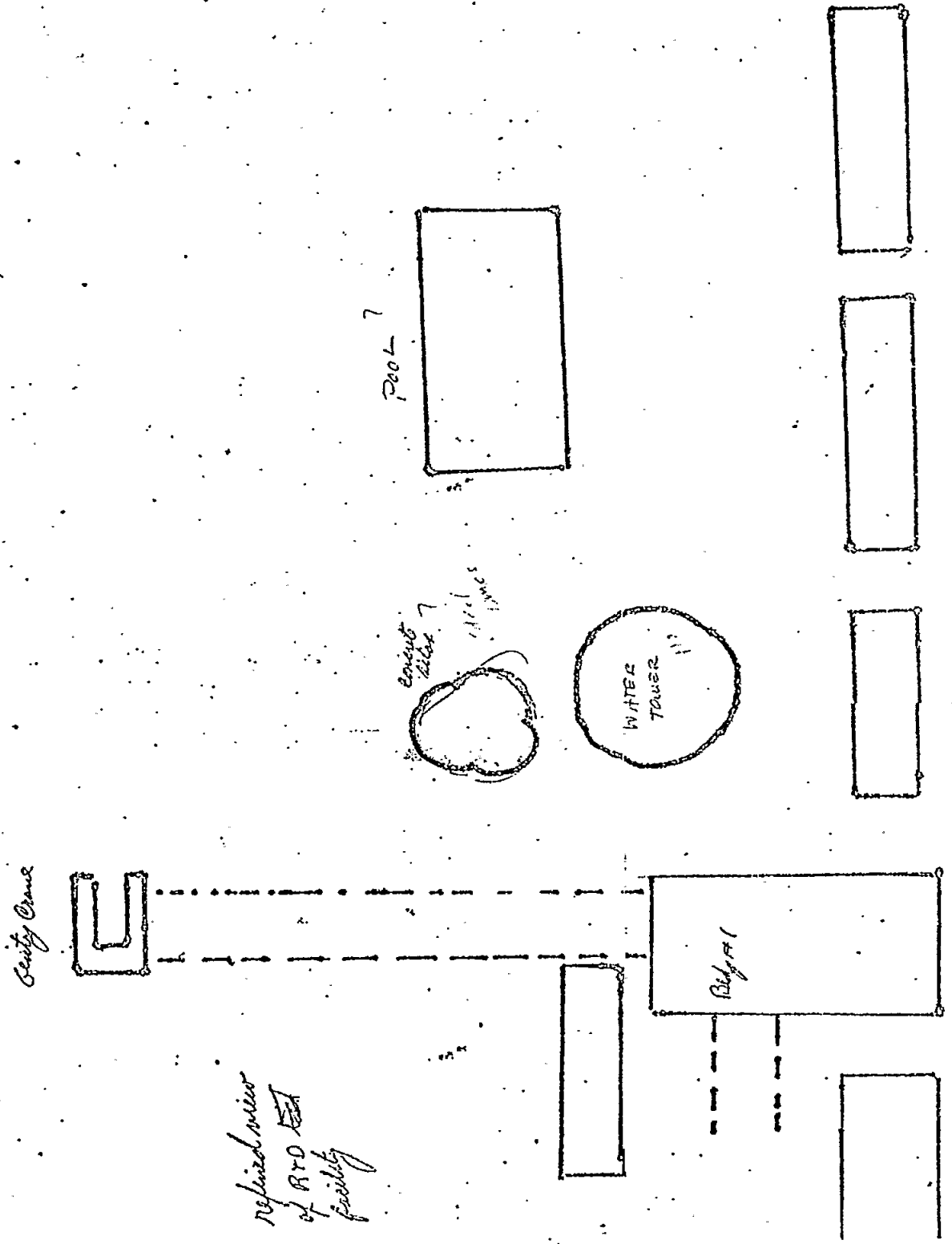

Sanitized - Approved For Release : CIA-RDP96-00791R000200240001-0

Figure 6.

JUL 10 1974
PM

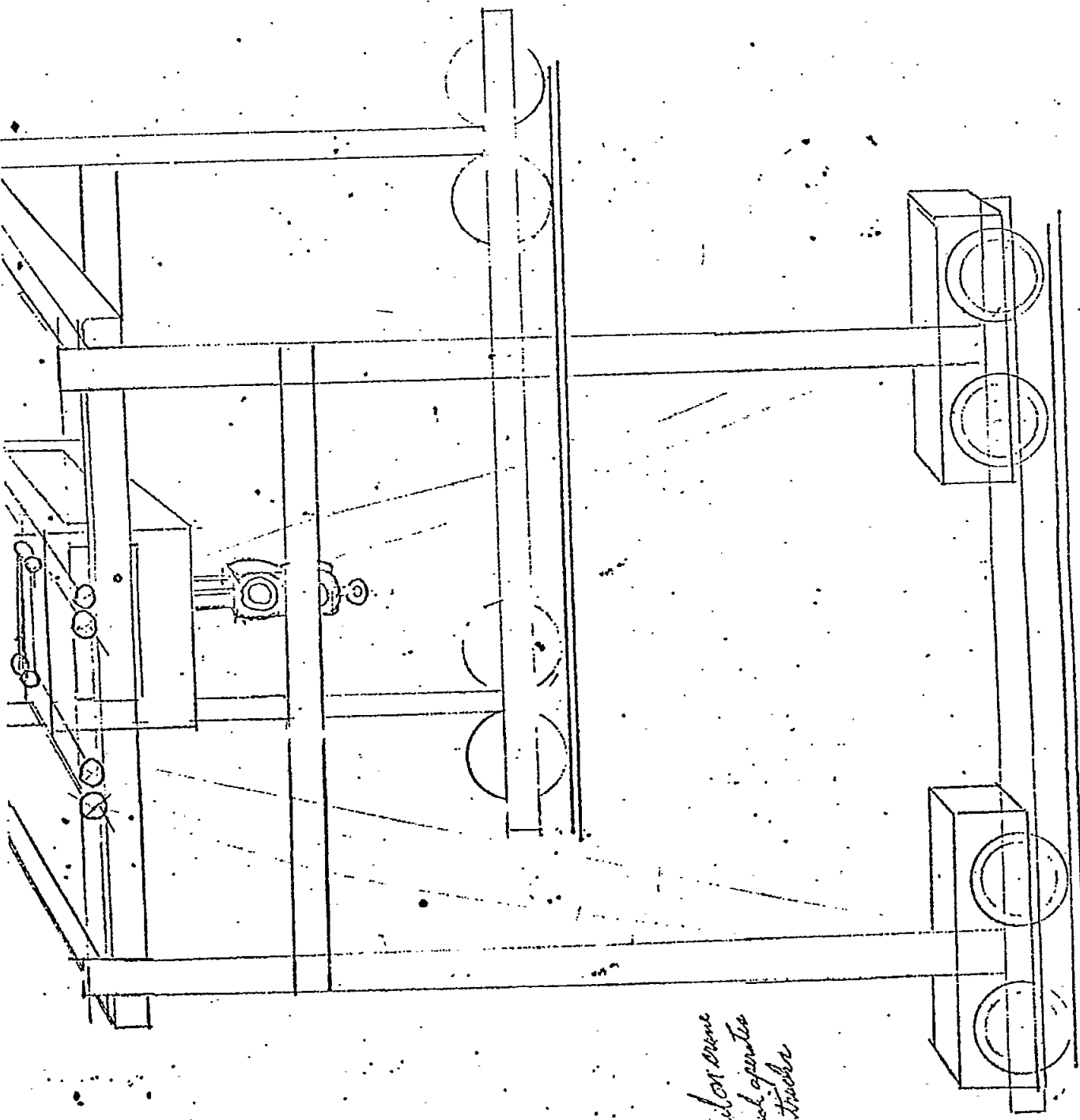

*detail on same
which operates
on truck*

(13)

JUL 10 1974 2 PM H

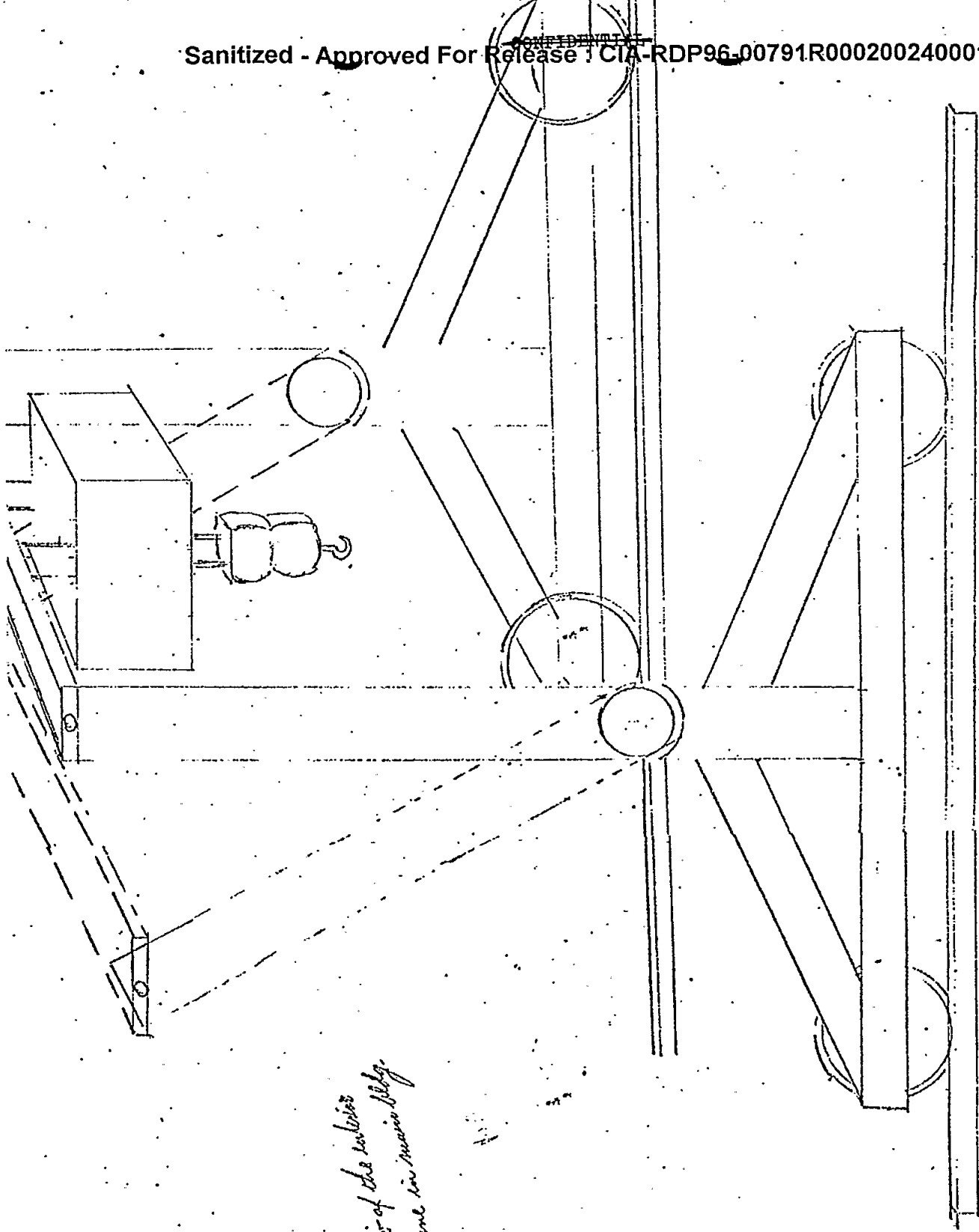

*view of the rollers
shown in previous drawing*

17

22
JUL 10 1974
PM

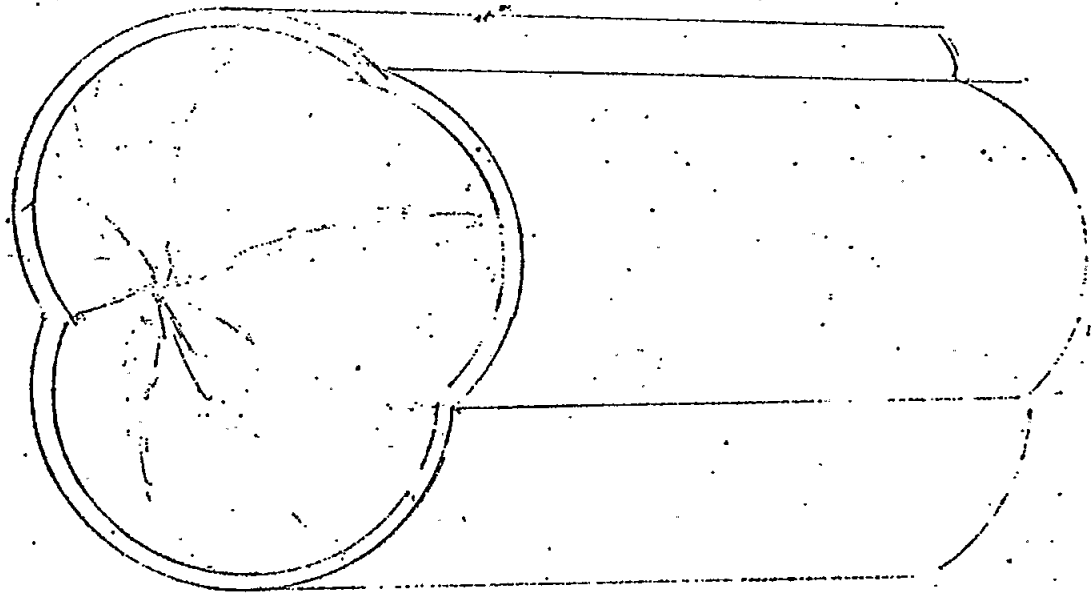
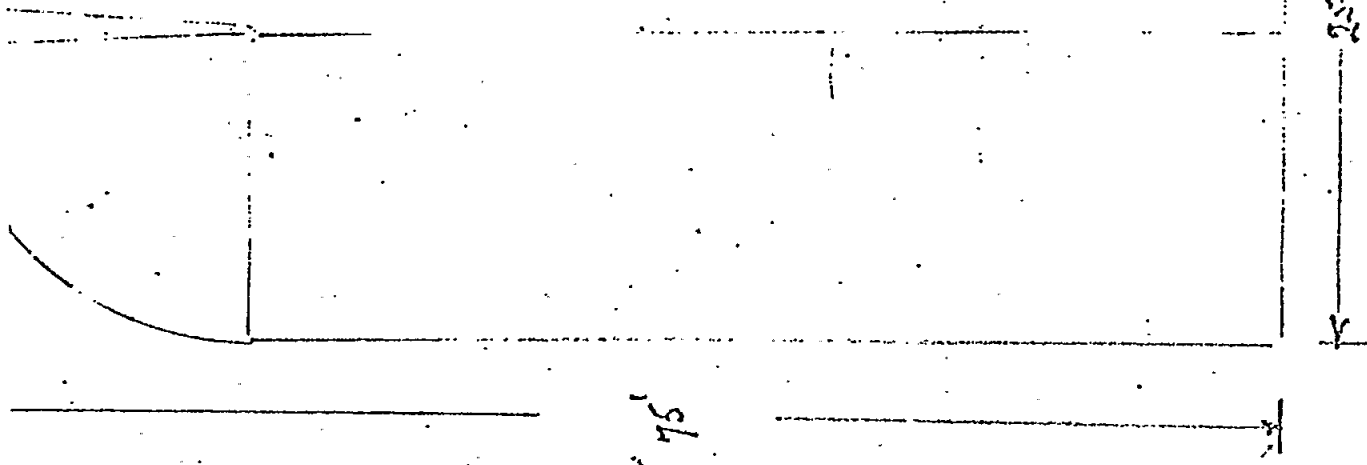

LAST-ERDA-OFFICIAL

Handwritten notes:
Serial of converted letter
Serial of # 16

Handwritten initials: PK

50

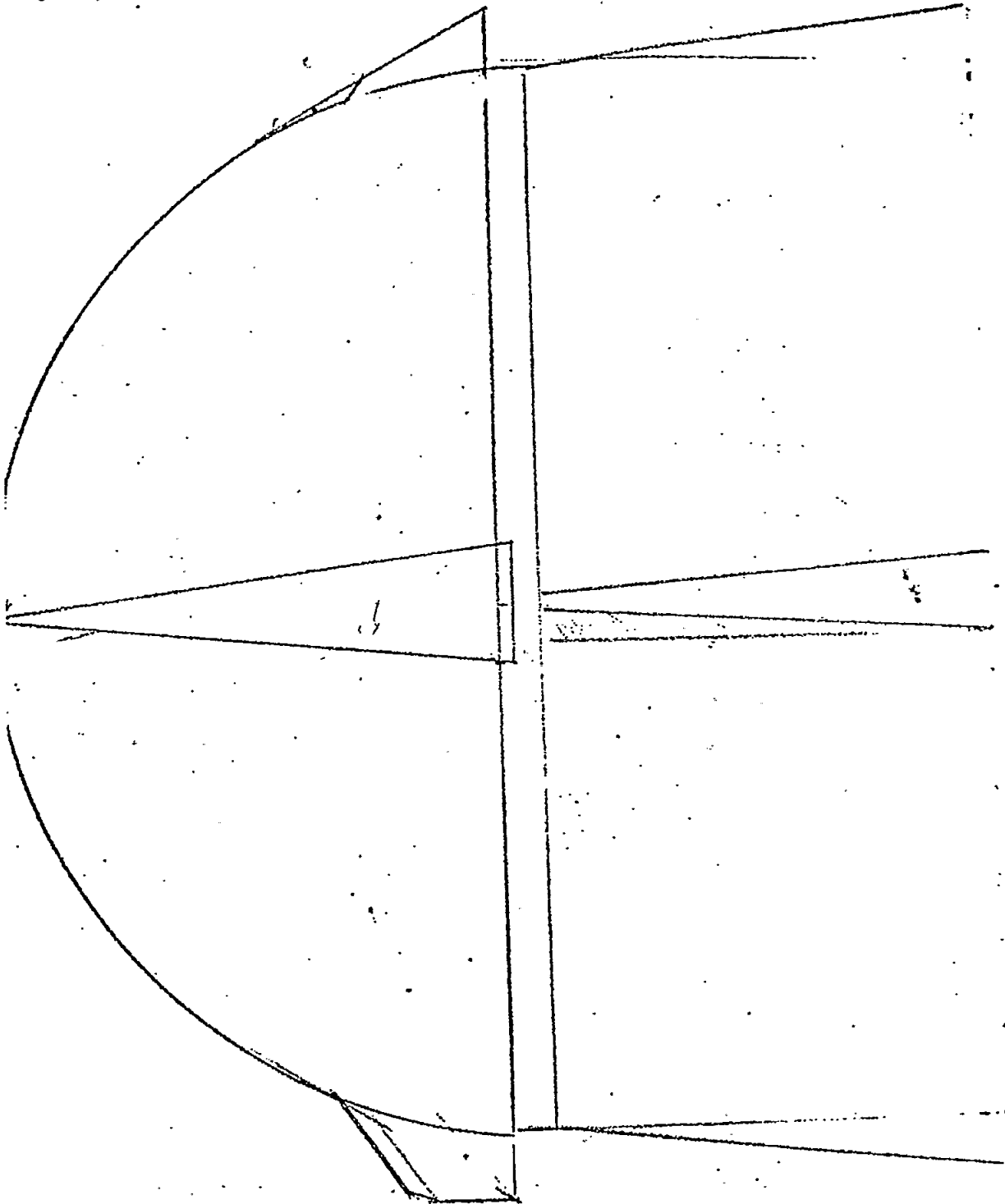

160

50

~~CONFIDENTIAL~~

Assuming the relationship of the gantry crane to Building 1 in Fig. 6 is the same as the relationship of the gantry crane to Building 1 at URDF-3, it must be concluded that ██████'s oriented 90° in error in the scientific complex. His north direction for the scientific complex only would correspond to what is actually east at URDF-3. His relationship of scientific complex to military complex to the Irtysh River is still correct though.

Unfortunately, the experimenters failed again to get a drawing of the perimeter fence for the scientific complex. In Fig. 5, I have taken the liberty of drawing a perimeter fence around the scientific complex and come very close to the actual shape of ██████'s perimeter fence of the Operations Area (scientific complex) at URDF-3. ██████ had been asked twice the day before to draw a perimeter of the area, but it wasn't followed up by the experimenters.

Summary of the Second Day

The controlled session at SRI lasted for one hour (11 a.m. until noon). The rest of the session was conducted ~~over~~ the telephone with only the voice of the experimenter recorded on tape. ██████ commented that he was seeing a lot of things that he hadn't seen the previous day and supplied the most positive evidence yet for remote viewing with his sketch of the rail-mounted gantry crane. It seems inconceivable to imagine how he could draw such a likeness to the actual crane at URDF-3 unless:

- 1) he actually saw it through remote viewing, or
- 2) he was informed of what to draw by someone knowledgeable of URDF-3.

I only mention this second possibility because the experiment was not controlled to discount the possibility that ██████ could talk to other people - such as the Disinformation Section of the KGB. That may sound ridiculous to the reader, but I have to consider all possibilities in the spectrum from his being capable to view remotely to his being supplied data for disinformation purposes by the KGB.

Discounting item 2 for the time being, because it seems distasteful and unpopular, ██████ did much better the second day toward establishing his

credibility in remote viewing. Unfortunately, the experimenters did not follow up on a couple of key items - a sketch of the perimeter of the scientific complex, and pursuing the "sunken building" comment that ██████ made. After studying only his sketch of the gantry crane, it's easy to believe that he can view remotely. I can understand how he might not see some landmark-type objects (like the four headframes) but I find it difficult to understand the other landmark-type objects he sees that simply do not exist at URDF-3, like his incorrect description of Building 1. One explanation could be that if ██████ mentions enough specific objects (such as three different types of gantry cranes when there is really only one), he will surely hit on one object that is actually present. If the user of ██████ remote-viewing talents had no way of checking, how could he differentiate the fact from the fiction? At this stage of the experiment, the data is inconclusive to validate ██████ capability of remote viewing.

THIRD DAY

Summary

The experiment began again at 11:43 a.m. on July 11, 1974. The data included 67 pages of transcribed tapes along with 6 sketches drawn that day by ██████. It was difficult to follow the discussion of ██████ and the experimenters when they were obviously looking at a sketch and saying things like, "What about this object over here?" I had no way of guessing which object and at which location and on which sketch.

SG1J

The experiment started with ██████ describing the specifics of the pool. At one time during this discussion I thought the pool he was looking at might well be the underground building (Building 1) at URDF-3.

SG1J

He incorrectly recalled the nearest railroad as being ██████ miles to the north even though on the first day, he had said the closest railroad was about 60 miles north.

During the early afternoon, the experimenters showed ██████ a sketch of a perspective of the southern part of the Operations Area at URDF-3 (see Fig. 11). The sketch included the rail-mounted gantry crane, the underground building (Building 1), the partially earth-covered tank, Building 4, and the four headframes.

~~CONFIDENTIAL~~

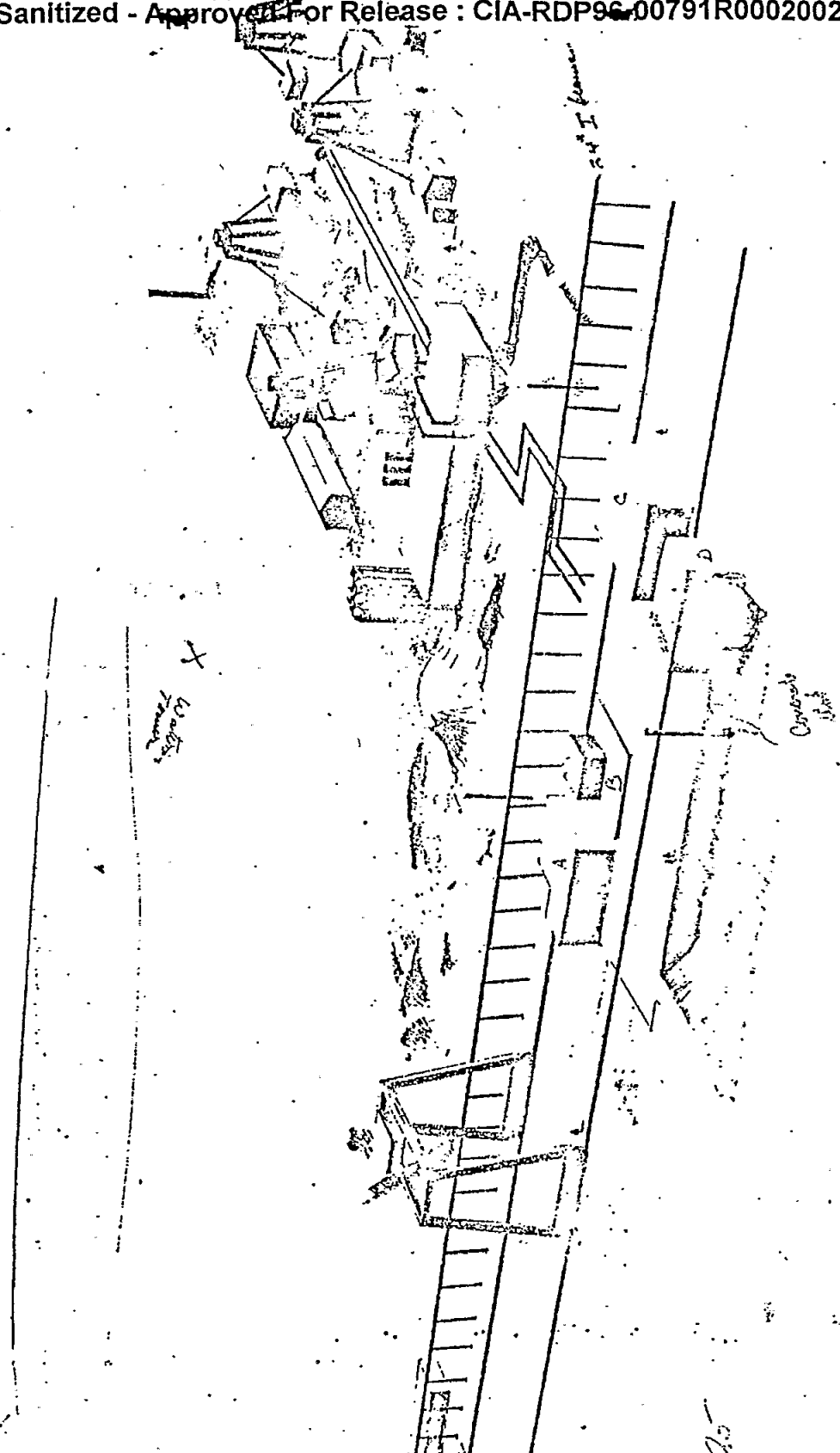

~~CONFIDENTIAL~~

They told him that this was a sketch of a perspective of the actual place and asked him whether he could now "see" the four headframes as shown in the sketch. He said he recognized the area as the one he had been seeing but claimed that only one of the four headframes was present now. That proved to be untrue, since all four headframes are still there.

As seen in Fig. 11, the sketch of Building 1 is deceiving in that it looks like there are really four buildings (A, B, C, and D as marked in Fig. 11) sitting atop a concrete slab rather than there being a 50-ft. deep underground building with four sections (A, B, C, and D) extending above the ground. [redacted] "looked" into the four "separate" buildings (A, B, C, and D) and described their contents in great detail but never suggested that this was all one large underground building. Finally, much later in the afternoon, it was requested that he investigate whether "Buildings A, B, C, and D" were really the surface elements of an underground building. He looked underground and said, "No, that's a concrete apron, and there's nothing subterranean right in that particular area." This description is the most negative evidence yet and tends to discredit [redacted] ability to remotely view URDF-3.

FOURTH DAY

Summary

The SG1 discussion on the fourth day (July 15, 1974) involved only Hal Puthoff and [redacted] was very specific regarding his concept of the overall operation at URDF-3. He recognized that from the beginning, he had been trying to force-fit a space-oriented situation to the target location, but now realized this "feeling" was incorrect.

This day, the discussions did nothing toward supplying any new evidence (that could be checked) to establish validity for [redacted] remote-viewing capability.

CONCLUSIONS AND RECOMMENDATIONS

SG1J

The experiment to determine the validity of [redacted] remote viewing of URDF-3 appears to be a failure. He described a scientific and military complex about 30 miles SW of the Irtys River, but this information

had been given to him earlier. He got very specific about details only to summarize with a comment like "I'll come back to that," but seldom did he ever "come back to that." He successfully evaded drawing a perimeter of the area even though he was asked to do this several times throughout the experiment; this was unfortunate because the shape of the perimeter is unique.

I can understand how he might not have seen some of the landmark-type objects at URDF-3, but it's difficult to understand how he "saw" the other landmark-type objects that simply do not exist at URDF-3. One explanation could be that if he mentioned enough specific items, he would surely hit on one object that is present which could explain the most positive evidence to support remote viewing for this experiment - a sketch of a rail-mounted gantry crane.

He was completely wrong in his description of how this crane was related to any building. Even after he was shown an actual sketch of the scientific complex, he failed to see the underground building (Building 1 at URDF-3) but "saw it" as four separate above-ground buildings sitting atop a concrete apron.

In trying to determine the validity of this remote-viewing experiment, the worth of the data to the eventual user has to be considered. If the user had no way of checking, how could he differentiate the fact from the fiction? In the case of URDF-3, the only positive evidence of the rail-mounted gantry crane was far outweighed by the large amount of negative evidence noted in the body of this analysis.

It's unfortunate that so much of the experiment was done over the phone. If this should happen in the future, both sides of the phone conversation should be recorded rather than just the experimenter's voice, as was done during this experiment. Also, the experimenters did not pursue some important details when they had a chance. This may have been a result of their unfamiliarity with the target. This was obvious when the experimenters didn't know which direction was north in the actual perspective of URDF-3. I suggest that in the future, at least one of the experimenters be totally familiar with the target. I also suggest that future experiments be more tightly controlled to discount the possibility of the subject discussing the material with people not involved in the experiment.

SG1J

After careful analysis of the data presented to me, I consider [REDACTED] remote-viewing experiment of URDF-3 to be unsuccessful. I recommend that the tapes be considered for use with the psychological stress evaluator (PSE) described in Appendix I; I am not competent to judge the reliability of the PSE as an aid to lie detection, but I think the tapes should be subjected to such a test.

APPENDIX I

from *Science*, Volume 190, No. 4212
dated October 24, 1975

CPYRGHT

Lie Detectors: PSE Gains Audience Despite Critics' Doubts

Ultimately, the PSE could affect human communication the way the development of the atomic bomb affected warfare.—International Moneyline, a newsletter.

The above agitated observation reflects the fascination felt in some quarters over a recently developed instrument called the psychological stress evaluator, or PSE. The PSE has become the first competitor of the polygraph (or lie detector) since the latter was developed in the 1920's. Whereas a polygraph tests a subject's psychophysiological responses to questioning by measuring his or her respiration, blood pressure, and skin conductivity, the PSE registers stress by measuring certain inaudible modulations in the voice. Because it can be operated simply with the tape recording of a voice, "it is the first lie detector that can be used on a dead man," notes its inventor, Allan D. Bell.

The PSE has been the object of considerable attention and controversy and the subject of articles in *Playboy* and *Penthouse*, as well as publications aimed at law enforcement and security personnel. Its reliability as an aid to lie detection has come under attack—notably in a study commissioned in 1973 by the Army—and its versatility and simplicity have aroused ethical

concerns because they give it a real edge over the polygraph when it comes to invading privacy.

The PSE was introduced a few years ago by Dektor Counterintelligence and Security, an adventurous little electronics company run by ex-Army sleuths who believe a man's reach should exceed his grasp. (Dektor was in the news last year, it may be recalled, for coming up with an ingenious counterexplanation for the 18½-minute gap in Rose Mary Woods' tape. See *Science*, 22 February 1974 and 21 June 1974.) The PSE was born in Allan Bell's basement. Bell, a retired Army intelligence officer who quit 5 years ago to form Dektor, says the search for a new way to measure stress was triggered by a market research assignment to come up with a way to measure the emotionality with which people answer questions by pollsters. Bell and the PSE's coinventors, Charles McQuiston and Bill Ford, set out to seek "identifiable emissions from the human body." Odors and voice were the best prospects, but odors are so numerous and cas-

ily dispelled or adulterated that they settled on the voice. They discovered that all muscles, including those controlling the vocal cords, vibrate slightly when in use, a phenomenon that is believed to be an involuntary function of the central nervous system. This is called the muscle micro-tremor and had already been identified, although the inventors didn't know it at the time—"we reinvented the wheel," says Bell. What was not known was that this tremor, which is transmitted to vocal cords, is suppressed by activity of the autonomic nervous system when the speaker is under stress. It is analogous, and may be directly related, to the suppression of the brain's alpha waves (which are associated with a relaxed waking state) when a person is making a conscious effort to think.

The PSE is more versatile than the polygraph because the subject is not required to be hooked up, immobile, to a machine, and, in fact, doesn't even need to be present; the analysis is made from a tape recording, and can be done on a tape made from a telephone conversation or a broadcast. In a lie detection situation the subject is asked the same carefully designed set of questions (innocuous "control" questions interspersed with significant ones) that are asked in a polygraph exam. The tape is then played back through the PSE—a portable affair ensconced in an inconspicuous black suitcase—at a speed four times slower than that at which it was recorded, and a needle on a moving graph chart plots the stress. If the waveform travels up and down erratically, the frequency modulation of the

24 OCTOBER 1975

359

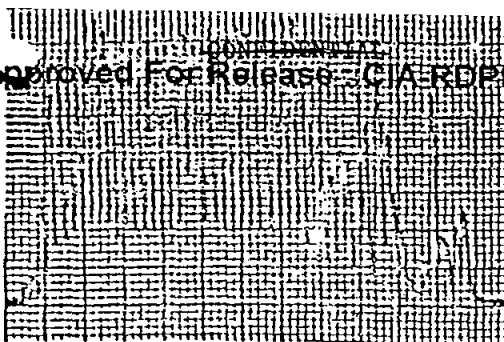
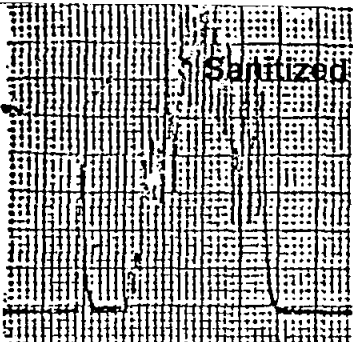

In an unstressed utterance, at left, the overall configuration resembles a wave, produced by the microtremor that oscillates at 8 to 14 cycles a second. The other chart shows heavy stress as the tremor is obliterated.

microtremor is being registered. This indicates no stress. When the speaker is under stress, however, the tremor is suppressed and tracings become more uniform.

Best known of the early PSE experiments is Dektor's run-through of contestants on the television show "To Tell the Truth." By taping each person when he said "My name is . . .," they claimed 95 percent accuracy in spotting the real John Does. The PSE made its forensic debut in Howard County, Maryland, where a police lieutenant named Michael Kradz, who subsequently joined Dektor, reported a number of successes using the PSE, most of which contributed to clearing suspects of offenses ranging from shoplifting to murder.

Dektor has sold more than 700 of the instruments (now priced at \$4200), mostly to retail and industrial firms who want to catch sticky-fingered employees, to private investigative firms, and to local law enforcement agencies. And sales are going up, says Bell, despite cold water thrown on the PSE by a report produced for the Army in 1973. The Department of Defense bought five of the machines and turned three of them over to the Army whose Land Warfare Laboratory paid Joseph Kubis, a psychologist and polygraph researcher at Fordham University, \$27,500 to conduct a comparative study of the worth of the polygraph, the PSE, and another machine similar to the PSE called the voice stress analyzer. Kubis, using laboratory subjects, gave the polygraph a 76 percent accuracy rating and the PSE 33 percent, or about the same as chance (he did a "triad" study, testing people in three roles—perpetrator, lookout, and innocent bystander).

The Kubis report has gotten a good deal of attention, and is cited by all the PSE's critics. Bell, of course, dismisses the study as a slipshod piece of work and says no other research has confirmed the Kubis findings. Kubis, however, says that one other well-controlled experiment agrees

with his conclusions, and that research with "live" cases, which Dektor favors, yield very poor results. The Army, while declining to give the Kubis report official endorsement, has nonetheless acted on its findings. It allocated one of the machines for use in research not related to lie detection, and "destroyed" the other two, according to an Army spokesman, who was as emphatic about disassociating the military from the PSE as if he had been asked about plans to deploy a new nerve gas.

The government is clearly in no hurry to attract more attacks on its surveillance habits, and Bell doesn't mind having this market closed to him, as he thinks the government is a nuisance to do business with anyway and not too bright.

Reliability aside, there has been considerable concern over the potential for unethical use of the PSE. The main problem is created by the fact that it can be used without the subject's knowledge. Robert Smith, formerly of the American Civil Liberties Union, points out that job interviews can be taped and run through the instrument without the person's knowledge and he can be denied employment on the basis of stressed-looking squiggles. He also says that the PSE, again unlike the polygraph, can be used in conjunction with wiretapping. And, he says, "people's careers can ride on other people going around analyzing their voice tapes." That comment is in reference to the fact that some PSE operators and journalists have been having fun analyzing the public utterances of various interesting people. Indeed, one freelance writer, ex-CIA computer specialist George O'Toole, has written a whole book explaining why Lee Harvey Oswald didn't kill anyone—based in large part on a PSE analysis of Oswald's statements after he was captured. ("I didn't shoot anybody, no sir," said Oswald with no stress.) Other colorful PSE uses have been the taping of John Bull (no stress) and John Mitchell (stress) at the Water-

nied ever having heard of Clifford Irving. Dektor claims to have known before anyone else that Irving was a fraud because their analysis of Hughes' PSE chart showed him to be sincere).

Allan Bell does not suffer moral dilemmas about any of this. First of all, he emphasizes, anyone who buys a PSE must take a 3-day training course in its use, and if the customer flunks there is no sale, or he can pay for more training until he passes. As for surreptitious use, Bell says that in uncontrolled conditions—such as taping a presidential press conference or a phone conversation—there is no way of telling whether a person is lying, only whether he is "stressing." No stress is a reliable indicator that a person thinks he is speaking truth, but stress can arise from a variety of causes that can only be weeded out in a carefully controlled situation. As for broader ethical considerations, Bell answers with a question: "Which is immoral—for a person to lie, or for a lie to be uncovered?" Bell suspects that some businessmen have bought the PSE to determine whether associates are squaring with them in business dealings, but that doesn't bother him—Dektor did the same thing, and canceled a deal because they believed they were being lied to about the promised delivery of some money.

Least enamored of the PSE is the 1200-member American Polygraph Association (APA), which in 1973 passed a resolution saying none of its members would be allowed to operate a PSE unless it were used in conjunction with a polygraph test. Kirk Barefoot of the APA says the PSE quite simply doesn't meet the organization's standards because a lie-detecting machine should be tuned into a minimum of two physiological responses, and the PSE measures only one. The APA also looks askance at PSE training requirements, as polygraph operators must go to school for 6 weeks followed by a 6-month internship.

Dektor counters these objections by attacking the motives of the APA. Bell says the two instruments are about equally reliable when used by skilled examiners with well-constructed tests; as for training, well, it's much easier to use a PSE. Bell says the obvious reason for APA hostility is that the PSE poses a threat to the tight-knit fraternity of polygraph operators. Many companies would naturally turn to the PSE because it's cheaper to have an in-house truth specialist, and it costs a lot to farm out an employee for polygraph training.

Dektor went after the law enforcement and security market because that's where the money and the people willing to spend it adventurously were to be found.

Sanitized - Approved For Release : CIA-RDP96-00791R000200240001-0

though, that the most interesting applications of the machine will be in psychological research, diagnosis, and testing.

The PSE can do several other things the polygraph can't. It can chart whole sentences in addition to simple yes-no answers to which the polygraph is limited. The PSE picks up stress instantaneously because the microtremor is the result of an electrical signal and does not have to wait

for the flow and ebb of body chemicals as does the polygraph, says Bell. "It can also register changes of stress levels within a single syllable. It can be used with more people in more situations because the subject is free to roam about, and intoxication with drugs or alcohol does not, it is claimed, distort the microtremor.

The academic community has not displayed much interest in the instrument to date—Bell explains that this community is

conservative almost to the point of being immobile"—but some researchers have been fooling around with it. One has done a study proving that stage fright increases in proportion to the number of people in an audience; another has analyzed stress among dental patients. One researcher, says Bell, has done psychological diagnoses of alcoholics using an "emotion-producing word test." By charting stress reactions to lists of words, the researcher can

determine the shape of the circumstances that have gotten the subject in his present fix. The success of tests such as this leads Bell to boast, "We can do 6 months worth of psychoanalysis in 10 minutes."

The psychological stress evaluator has an interestingly ambivalent status as both a forensic and a clinical instrument. As the Michigan attorney general wrote in response to a request for clarification of the PSE status under Michigan's polygraph examiners law: "... a very narrow line separates the use of mechanical devices for the purpose of measuring stress and the use of such device to determine truthfulness." (He decided that the act did apply to the PSE in the latter case.) Forensically speaking, the PSE is in a kind of limbo. Nineteen states have laws licensing or regulating polygraph use, and presumably in those states where other instruments are not banned, forensic use of the PSE would be decided on a case-by-case basis. One state, North Carolina, licenses PSE operators (80 hours of training is required); elsewhere, a person armed with nothing but a Dektor training certificate can call himself a PSE operator. The other states, including New York and California, have no laws because of strenuous opposition by labor unions to legislation they think will legitimize the use of lie detectors in employment (six states now ban compulsory preemployment polygraph testing).

One individual who is determined that

the PSE shall gain full respectability in the eyes of the law is John W. Heisse, a Burlington, Vermont, otolaryngologist. Heisse is the head of the International Society of Stress Analysts (ISSA), a fledgling organization of 200 PSE, polygraph, and voice analyzer users from the fields of law enforcement, industrial security, business, law, and health. Heisse is perhaps the PSE's most fervid partisan. He has rerun the Kubis study, using the contract's "alternate specifications," and claims the PSE came out with 97 percent reliability. He has used the instrument to prove that people with laryngectomies still register muscle microtremor; he has tested the effects of dozens of drugs on PSE subjects. He has a "death test" to see how anxious people are about death, and a suicide test—five questions relating to death that can be asked over the phone. If the subject shows no stress in answering, it means he is definitely preparing to kill himself. Heisse says in seven cases the test unfortunately proved correct. He has also tried the PSE with hypnotized subjects and discovered that they show no muscle microtremor—not because of stress but because they are unusually relaxed. He says the same finding applies to persons who have been brainwashed. (Quick to see an application here, Heisse went off to San Francisco to chart Patty Hearst's tapes, but he won't tell what he found.)

In addition to these activities, Heisse

says he has been doing all the lie-detecting work for the city of Burlington—that is, until Vermont passed a law saying only polygraphers can do truthfulness verification work. Heisse believes this law was passed just to protect the jobs of Vermont's three polygraphers. He has raised \$100,000, gathered 300 pages of evidence, and is suing the state of Vermont. The outcome of this case could set a significant precedent if and when PSE's proliferate enough to attract the attention of other lawmakers.

Meanwhile Allan Bell wants to go back to the drawing board. "The PSE is to stress analysis of the voice what the Model T is to locomotion," he declares. More work needs to be done on waveform analysis, on quantitative measures of mind-body interaction, and on "flesh mechanics." The stress evaluator, he points out, is measuring something no one has been able to define, so it would be nice to really pin it down, perhaps by locating the specific area of the brain where stress originates. One of the possible "end product configurations" envisaged by Bell's agile mind would be a machine that supplied a continuous meter readout of stress levels to a psychiatrist while his patient lay chatting on the couch. Some might find this a distressing symptom of human willingness to defer to machines. But fortunately, unlike the atom bomb, the PSE is only as effective as he who operates it.—CONSTANCE HOLDEN

Sanitized - Approved For Release : CIA-RDP96-00791R000200240001-0