

misc # 13
186 pages

18 OCT 1989

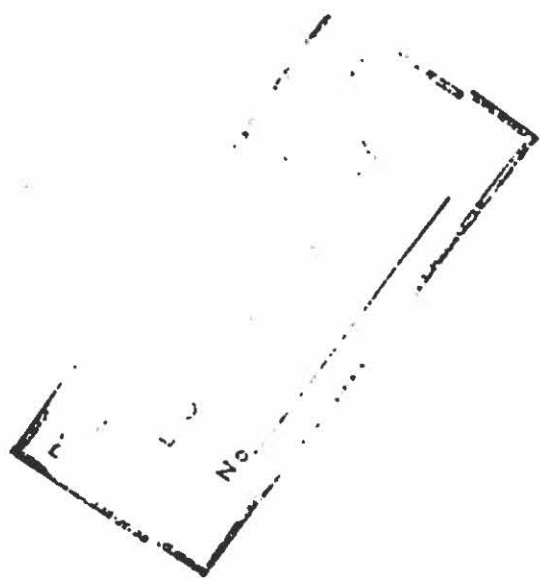
RETURN TO
Historical Research Division
ASI/HQA
Maxwell AFB, AL 36112

Handwritten notes and markings on the right side of the page.

LUNAR EXPEDITION

PLAN

LUNEX



REVIEW ON 31 Dec 1991

MAY 1961

DOWNGRADED AT 12 YEAR
INTERVALS UNLESS OTHERWISE SPECIFICALLY
DECLASSIFIED. DOD DIR 5200.10

HEADQUARTERS

SPACE SYSTEMS DIVISION

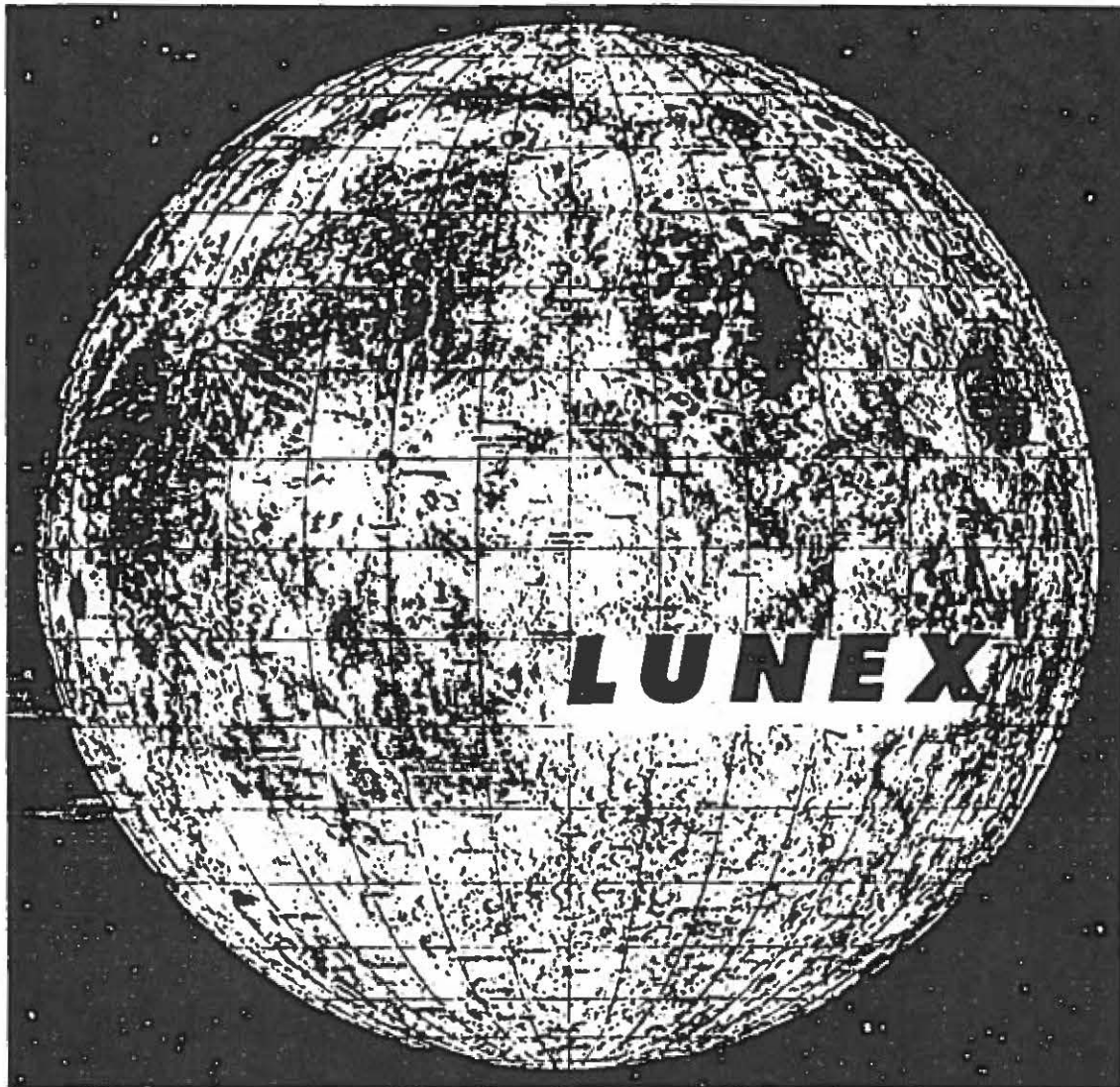
AIR FORCE SYSTEMS COMMAND

[REDACTED]

WDLAR-5-458

[REDACTED]

Handwritten reference numbers: 3-6510-13, 00920459



GENERAL LUNAR DATA

Distance from earth	
mean (miles)	239,000
(kilometers)	387,000
Diameter	
miles	2160
kilometers	3480
Temperatures	
sun at zenith	+101°C to +130°C
night	-153°C

GRAPHIC INFORMATION

Names

The feature names selected were adapted from the 1935 International Astronomical Union nomenclature system with minor changes by Yerkes Observatory in 1959.

Projection

An orthographic projection portrays the moon as a sphere in the true perspective created by viewing from an infinite distance.

Control

This is a controlled mosaic. Position was determined through the use of selenographic control established primarily from the measures of J. Franz and S. A. Saunders. A collated listing of these positions was published under the auspices of the International Astronomical Union in 1935.

Photography

The mosaic is comprised of photographs taken at Yerkes, Mt. Donald and Mt. Wilson Observatories. Photographs with high consistent sun angles were selected to maintain uniform portrayal of lunar craters and prominences and discernible maria regions.

Orientation

Cardinal directions have been established to conform with cartographic tradition, north to top and east to right, rather than astronomical convention. This orientation positions the moon in its true relationship to the earth. 180° of the visible disc at mean libration is shown.

NAMES LEGEND

Craters

(diameters in miles)	
100 and over	CLAVIUS
50 to 100	TYCHO
less than 50	HEVELIUS

Mountain Ranges

(length in miles)	
400 and over	ALPINE MOUNTAINS
less than 400	ALPES

Mountain Peaks, Valleys, Walls and Rilles

CLAVIUS
TYCHO
HEVELIUS

ALPINE MOUNTAINS
ALPES

HEVELIUS BRIS

Oceans, Gulfs, Bays, Seas, etc

(length of major axis in miles)	
600 and over	MARE IMBRIUM
200 to 600	MARE SERENITATIS
less than 200	SINUS IRIUS

MARE IMBRIUM
MARE SERENITATIS
SINUS IRIUS

5-6570-13
 00920459

SECRET

[REDACTED]

**PROPOSED SYSTEM PACKAGE PLAN
FOR
LUNAR EXPEDITION**

Prepared by Support Systems Plans Division

Approved by Norair M. Lulejian
Norair M. Lulejian
Colonel, USAF
Director, Advanced
Systems Plans And Analysis

DOWNGRADED AT 12 YEAR
INTERVALS; NOT AUTOMATICALLY
DECLASSIFIED. DOD DIR 5200.10

[REDACTED]

WDIAR-S-458

SECRET

[REDACTED]

CONTENTS

I.	SUMMARY
II.	PROGRAM DESCRIPTION
III.	MASTER SCHEDULES
IV.	DEVELOPMENT - TEST - PRODUCTION
V.	BUDGET AND FINANCIAL
VI.	PROGRAM MANAGEMENT
VII.	MATERIEL SUPPORT
VIII.	CIVIL ENGINEERING
IX.	PERSONNEL AND TRAINING
X.	INTELLIGENCE

Appendix #1 Glossary of Terms

WDLAR-S-458

[REDACTED]

1



SECTION I

SUMMARY

LUNAR EXPEDITION (U)
(LUNEX)

1.1

WDLAR-S-458





RECORD OF CHANGES

CHANGE NO.	DESCRIPTION OF CHANGE	DATE OF CHANGE	REFERENCE TO BASIC PART





INDEX

TITLE PAGE 1.1

RECORD OF CHANGES 1.2

INDEX 1.3

1.0 SUMMARY 1.5

1.1 PURPOSE 1.5

1.2 BACKGROUND 1.5

1.3 DESCRIPTION 1.5

1.4 MAJOR PROBLEM AREAS 1.7

1.5 MILESTONES 1.7

1.6 CAPABILITIES DEVELOPED 1.8

1.7 MANAGEMENT ACTIONS REQUIRED 1.8

ATTACHMENTS

CHART I-A LUNAR EXPEDITION PROGRAM MILESTONE SCHEDULE

CHART I-B LUNAR EXPEDITION MANAGEMENT MILESTONES FY62 - FY63





Intentionally left blank

1.4

WDLAR-S-458



1.0 SUMMARY

1.1 PURPOSE

The Lunar Expedition has as its objective manned exploration of the moon with the first manned landing and return in late 1967. This one achievement if accomplished before the USSR, will serve to demonstrate conclusively that this nation possesses the capability to win future competition in technology. No space achievement short of this goal will have equal technological significance, historical impact, or excite the entire world.

1.2 BACKGROUND

Extensive studies by Air Force-Industry teams during 1958, 1959, and 1960 examined all facets of the problem and techniques of sending men to the moon and resulted in a feasible concept which is attainable at an early date and is economical and reliable. Laboratories within the Air Force participated in this effort, thus establishing a broad technological base which can react quickly to an expanded high priority program.

1.3 DESCRIPTION

The lunar mission would be initiated by the launching of the lunar payload by a large, three-stage liquid or solid propellant booster to escape velocity on a lunar intercept trajectory. The payload, consisting of a Lunar Landing Stage, Lunar Launching Stage and a manned vehicle, would use a lunar horizon scanner and a doppler altimeter for orientation prior to a soft landing using the Lunar Landing Stage. Terminal guidance using prepositioned beacons would be required for landing at a preselected site. The Lunar Launch Stage would provide the necessary boost for the return to earth of the manned Lunex Re-entry Vehicle. Using mid-course guidance and aerodynamic braking, the vehicle would effect re-entry and a normal unpowered aircraft landing at a ZI base.

In addition to the manned vehicle a cargo payload is included in this plan. The cargo payload would utilize the same three-stage earth launch booster and the same lunar landing techniques. However it would not be returned to earth and would be used only to transport supplies and cargo to the expedition on the moon.

The primary concept recommended in this plan is the "direct shot" method since studies have indicated it could be available

1.5

WDLAR-S-458

[REDACTED]

at an earlier date and it would be more reliable. Another concept is also suggested which consists of the rendezvous and assembly of components in an earth orbit before injection into a lunar trajectory. The techniques and development required for this latter concept are documented under a separate SSP titled, SAINT. Therefore, no details of this concept are presented in this plan. All schedules relating the two plans have been coordinated to insure compatibility and to take advantage of mutual advances. Since neither rendezvous techniques nor large boosters have been demonstrated, both approaches must be pursued until it becomes obvious that one of them has clear advantages over the other.

The following developments are required in order to accomplish the lunar expedition:

a. A three-man Lunex Re-entry Vehicle. This vehicle must be capable of re-entry into the earth's atmosphere at velocities of 37,000 ft/sec. It must also be capable of making a conventional aircraft landing. Control and improved guidance for entering the earth's atmosphere at the proper place and angle is needed as well as improved materials to withstand the high surface temperatures. Adequate life support equipment is also required. The development of this vehicle is the key to the accomplishment of the LUNEX program and is one of the pacing development items. A detailed schedule for its development is included.

b. A Lunar Landing Stage for decelerating and landing the entire payload. This stage must have the capability to decelerate 134,000 pounds from a velocity of almost 9,000 ft/sec to 20 ft/sec at touchdown. A doppler altimeter is required to provide information for ignition and control of the engine. Horizon scanners must be used to orient the payload to the local vertical.

c. A Lunar Launch Stage capable of launching the manned Lunex Re-entry Vehicle from the lunar surface. Lunar ascent guidance is required to place the vehicle on the proper trajectory.

d. A three-stage earth launch booster, referenced as a space launching system. The first stage will use either LOX/LH₂ with six million pounds of thrust or a solid fuel with an equivalent launch capability. The second and third stages will use LOX/LH₂. The development of this space launching system is considered the pacing development item for the LUNEX program. Because of the magnitude of the booster program and the applicability of the

[REDACTED]

booster to other programs, the plan for its development is being presented separately.

In addition to the above listed hardware developments, additional information is required about the lunar surface such as its physical and roughness characteristics. High resolution photographs of the entire lunar surface may provide this information. Present NASA plans if expedited could provide the information for this LUNEX program. NASA's SURVEYOR (soft lunar landing) program could also incorporate radio-light beacons which would be used later in conjunction with a terminal landing system. A core sample of lunar material is required as soon as possible so that design of lunar landing devices and lunar facilities can be accomplished.

1.4 MAJOR PROBLEM AREAS

The development of techniques for re-entering the earth's atmosphere at 37,000 ft/sec is one of the major problems. Guidance equipment must be very accurate to insure that the re-entry angle is within $\pm 2^\circ$. Too steep an entry angle will cause overheating and intolerable G loads, while too shallow an entry angle may permit the Lunex Re-entry Vehicle to skip out of the atmosphere into a highly eccentric earth orbit. If this happens, the vehicle may spend several days in the trapped radiation belts and may exceed the time limits of the ecological system.

The Lunar Landing Stage will be a difficult development because of a requirement for orientation with the local vertical when approaching the moon. It must also be guided to the selected landing site. Many tests will be required to develop the necessary equipment.

The Lunar Launching Stage will be another difficult development. The prelaunch countdown must be performed automatically and, if the launching booster is not vertical upon launch, corrections must be made in order to attain the required moon-earth trajectory.

Although the foregoing developments are difficult, no technological break-through will be required. All designs can be based on extrapolation of present technology.

1.5 MILESTONES

Major milestones in the program are:

1.7

WDLAR-S-458

[REDACTED]

a. Recovery of a manned re-entry vehicle from 50,000 miles in 1965.

b. Manned circumlunar flight in 1966.

c. Manned lunar landing and return in 1967.

These and other significant events are shown on Chart I-A.

1.6 CAPABILITIES DEVELOPED

The development of large boosters, rendezvous techniques and maneuverable space vehicles, all required for the Lunar Expedition, will also provide a capability for many new and advanced space achievements. For example, the Space Launching System which will boost 134,000 pounds to escape velocity will boost approximately 350,000 pounds into a 300 nm orbit, or will launch a manned vehicle on a pass around either Mars or Venus.

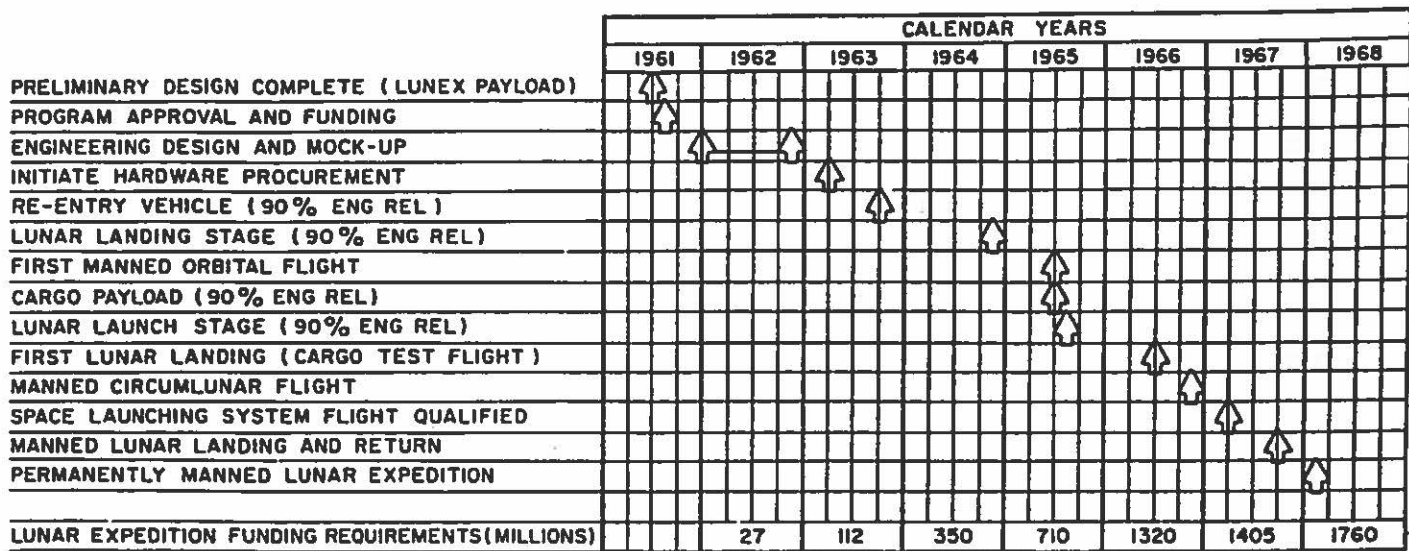
1.7 MANAGEMENT ACTIONS REQUIRED

The major Management Milestones for FY62 and FY63 are shown on Chart I-B. Immediate attention by Management to obtain Program Approval and Funding by July 1961 is necessary if the United States is to put a "man on the moon" by August 1967.

Throughout the LUNEX program time allocated for management and Air Force technical evaluations has been kept to a minimum. This is essential to meet the schedules, and delays in providing funding as indicated, or in receiving notification of required decision, will have the direct effect of delaying the program end objective.

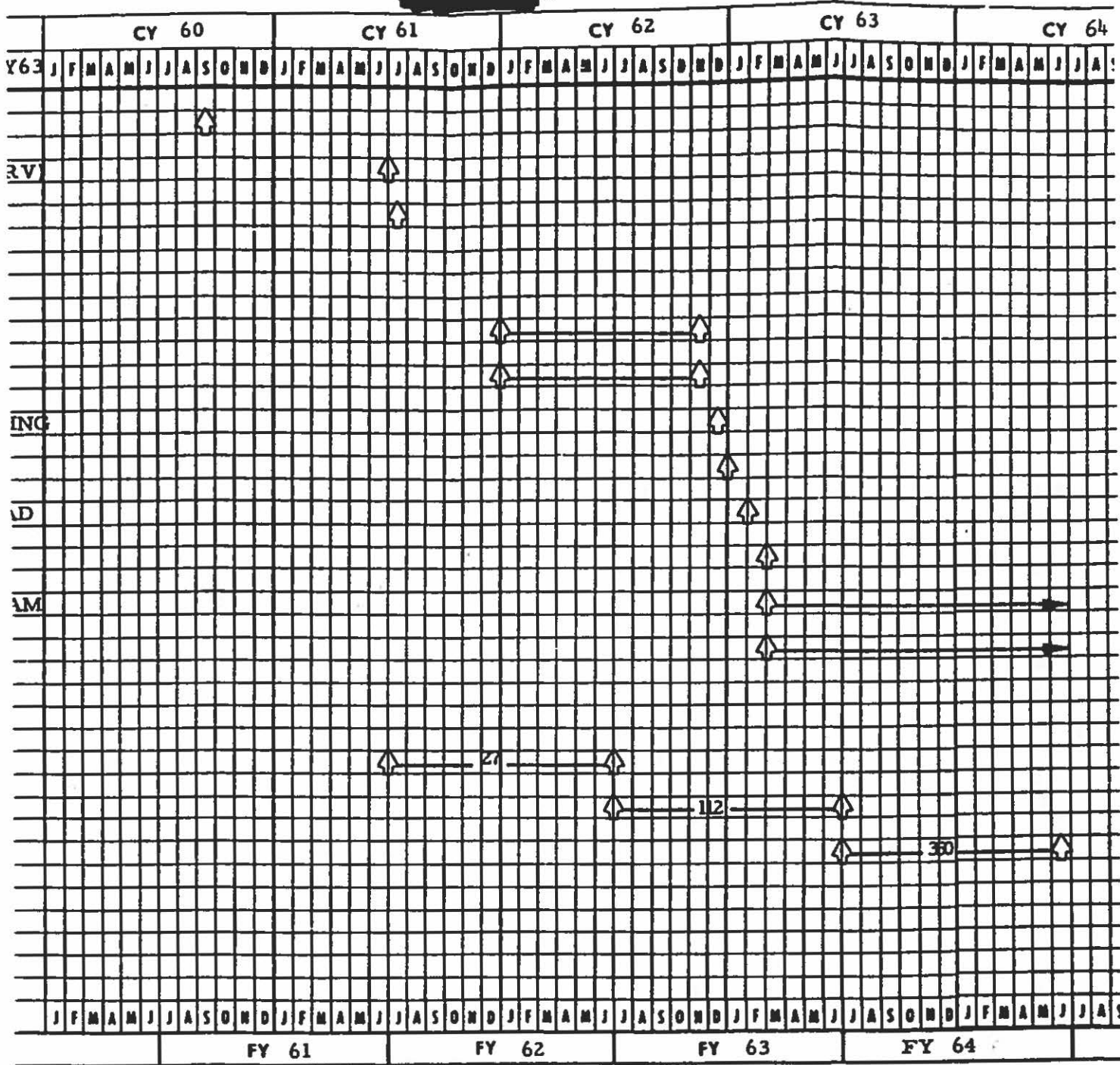


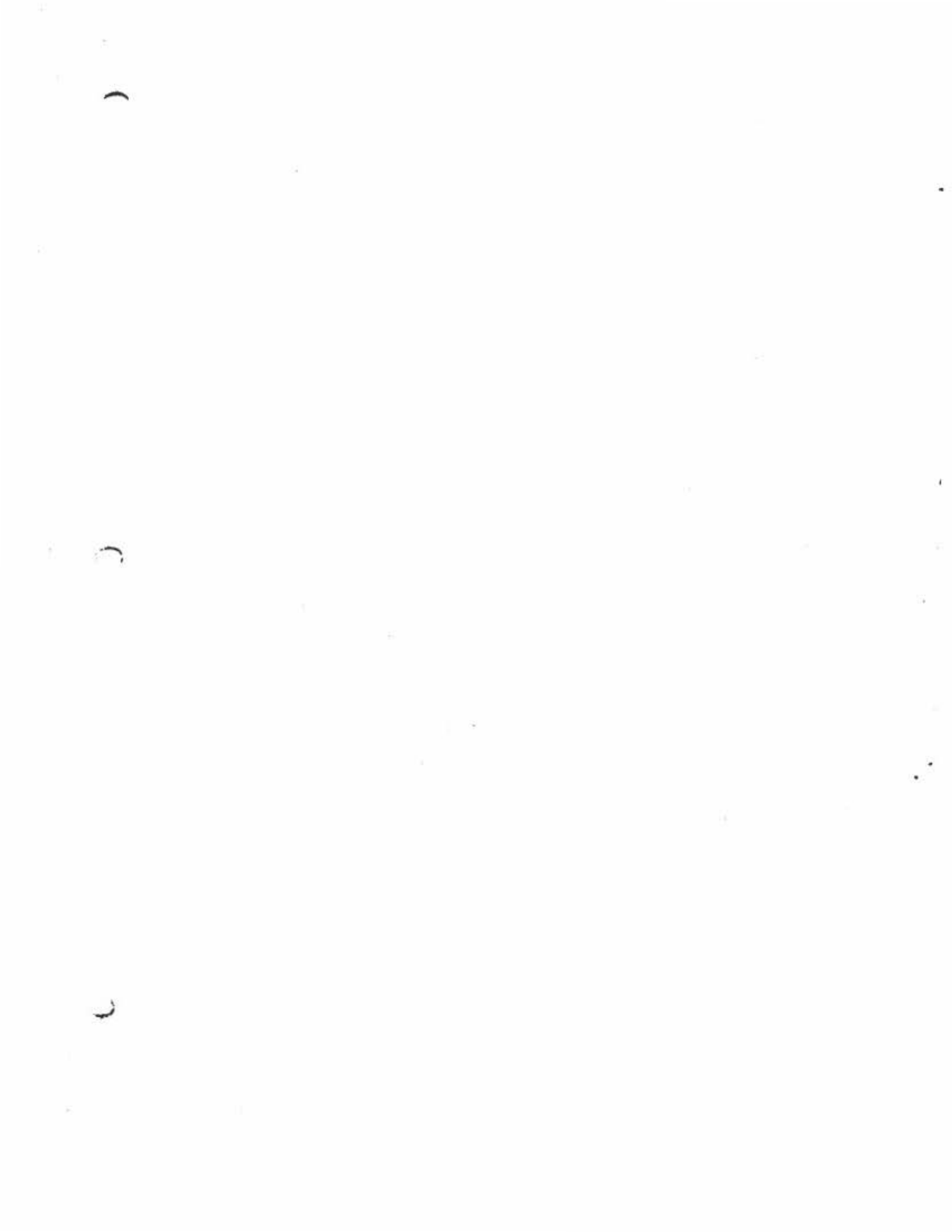
CHART I - A
LUNAR EXPEDITION PROGRAM MILESTONE SCHEDULE



WDLAR-S-45B









SECTION II

PROGRAM DESCRIPTION

LUNAR EXPEDITION (U)
(LUNEX)

2.1

WDLAR-S-458

[REDACTED]

RECORD OF CHANGES

CHANGE NO.	DESCRIPTION OF CHANGE	DATE OF CHANGE	REFERENCE TO BASIC PART



INDEX

TITLE PAGE 2.1

RECORD OF CHANGES 2.2

INDEX 2.3

2.0 BACKGROUND 2.5

2.1 LUNEX PROGRAM OBJECTIVE 2.5

2.2 LUNEX PROGRAM - DESCRIPTION 2.5

2.3 DESIGN PHILOSOPHY 2.7

2.4 ABORT PHILOSOPHY 2.7

2.5 EXPEDITION PLANNING 2.11





Intentionally Left Blank

2.4

WDLAR-S-458





2. PROGRAM DESCRIPTION

2.0 BACKGROUND

Shortly after the first Sputnik was launched in October 1957, Headquarters, ARDC initiated a series of studies to examine the military potential of space operations. These studies were accomplished by Industry-Air Force teams each working independently. Two of these studies which were the forerunners of this Lunex plan were "Lunar Observatory" and "Strategic Lunar System." The objective of the first study was to examine an economical, sound and logical approach for establishing a manned intelligence observatory on the moon, and the second study examined the military potential of lunar operations. These studies showed that it is technically and economically feasible to build a manned lunar facility.

A third study titled, "Permanent Satellite Base and Logistic Study" is presently under way and will be completed in August 1961. This study will provide a conceptual design of a three-man re-entry vehicle which will carry men to and from the moon. The three-man vehicle is the key item in the lunar transportation system as its weight will dictate the booster sizes. For this reason it is given special attention in this plan.

2.1 LUNEX PROGRAM OBJECTIVE

The objective of the Lunar Expedition program is the manned exploration of the moon with the first manned lunar landing to occur as soon as possible. The execution of this plan will land three men on the moon and return them during the 3rd quarter of calendar year 1967, and will establish the Lunar Expedition in 1968. Completion of this plan will require the development of equipment, materials, and techniques to transport men to and from the lunar surface and to provide a lunar facility which will allow men to live and work in the extremely harsh lunar environment.

2.2 LUNEX PROGRAM - DESCRIPTION

The Lunar Expedition Program is primarily concerned with the development of the equipment necessary to transport men and supplies to the lunar surface.

The key development in this program is the Lunar Transport Vehicle which is composed of the Space Launching System and either the Manned Lunar Payload or the Cargo Payload. The Manned Lunar Payload consists of a three-man Lunex Re-Entry Vehicle, a Lunar Launch Stage, and a Lunar Landing Stage. The same Lunar Landing Stage, plus a cargo package, composes the Cargo Payload. The relative effort required for the development of these

[REDACTED]

two payloads in comparison with other portions of the complete Lunar Expedition Program is shown in Figure 2-1. A breakdown of the Lunar Transport Vehicle is shown in Figure 2-2.

The Space Launching System consists of a three-stage booster capable of placing either the Manned Lunar Payload or the Cargo Payload on a lunar intercept trajectory at escape velocity. This plan does not contain development information on the Launching System since such information is contained in a separate System Package Plan being prepared concurrently. The development schedules in these plans have been coordinated to insure compatibility.

In operation, the Manned Lunar Payload, weighing 134,000 pounds, will be boosted to escape velocity of approximately 37,000 ft/sec on a trajectory which intercepts the moon. Velocity will be sufficient to reach the moon in approximately 2½ days. As the Manned Lunar Payload approaches the moon it is oriented with the local vertical by the use of horizon scanners. The Lunar Landing Stage decelerates the Manned Lunar Payload for a soft landing at a preselected site using an altitude sensing device to determine time of ignition. Landing at the preselected site will be accomplished using terminal guidance equipment and a prepositioned beacon to effect an off-set landing.

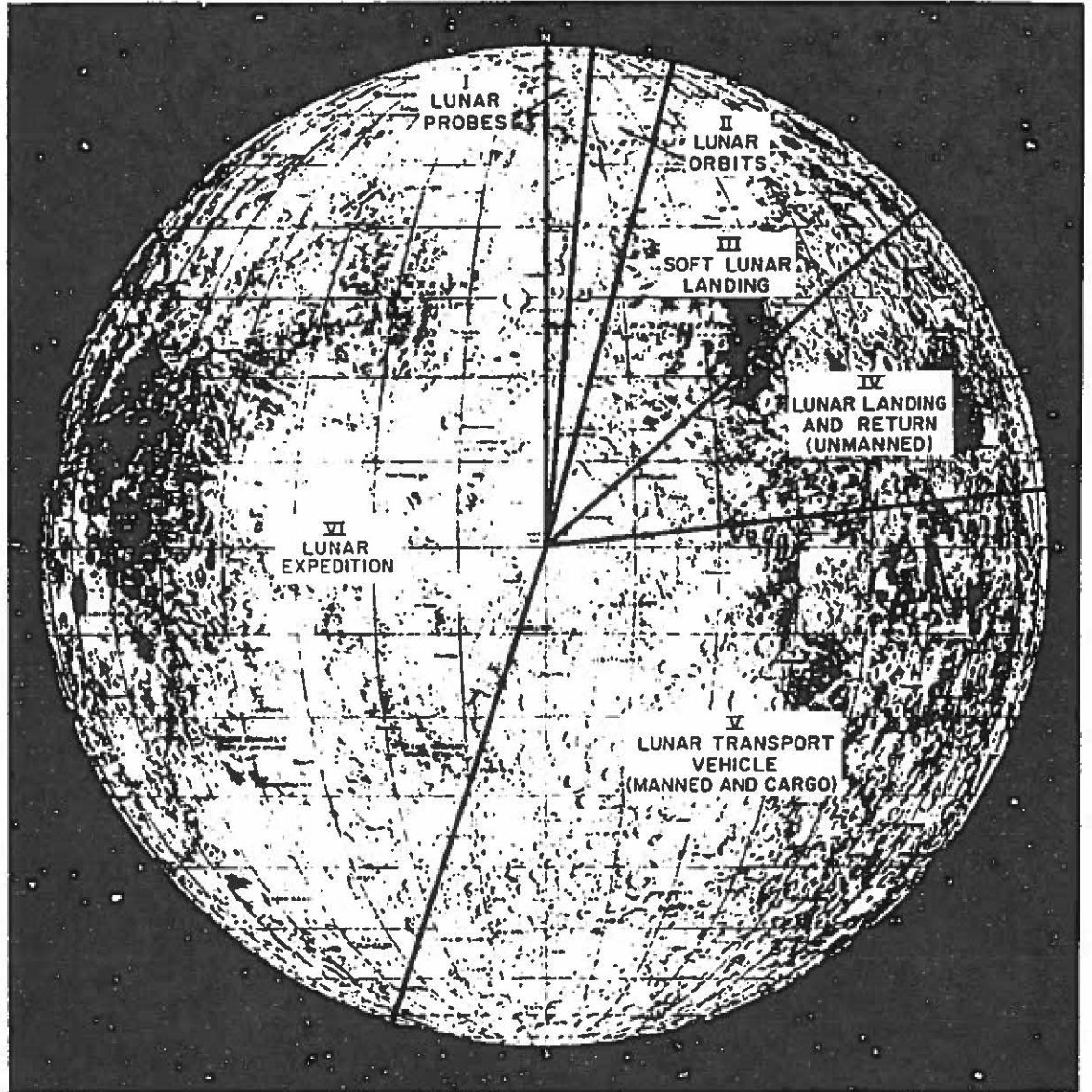
The Lunar Launching Stage, using the Landing Stage as a base, will launch the Lunex Re-entry Vehicle on the return trajectory. In early test shots before men are included, the countdown and launch will be effected automatically by command from the earth. Small mid-course corrections may be necessary to insure re-entry into the earth's atmosphere within allowable corridor limits.

The Lunex Re-entry Vehicle will re-enter the earth's atmosphere within the allowable corridor so that it will not skip back into space again nor burn from excess heat. It will use aerodynamic braking to decelerate and will have sufficient lift capability to effect a normal unpowered aircraft landing at a base such as Edwards Air Force Base.

Several successful unmanned, completely automatic flights of the type just described must be completed in order to establish confidence in the system reliability before manned missions will be attempted.

Cargo will be transported to the lunar surface using the same procedures and equipment except that the Lunar Launch Stage is not needed. The Cargo Package will have a weight equal to the combined weight of the Lunex Re-entry Vehicle and the Lunar Launch Stage.

As a separate approach to the problem of placing large payloads on the moon, techniques of rendezvous and assembly in earth orbit



DIVISION OF LUNAR EXPEDITION PROGRAM - LUNEY

WDLAR-S-45B

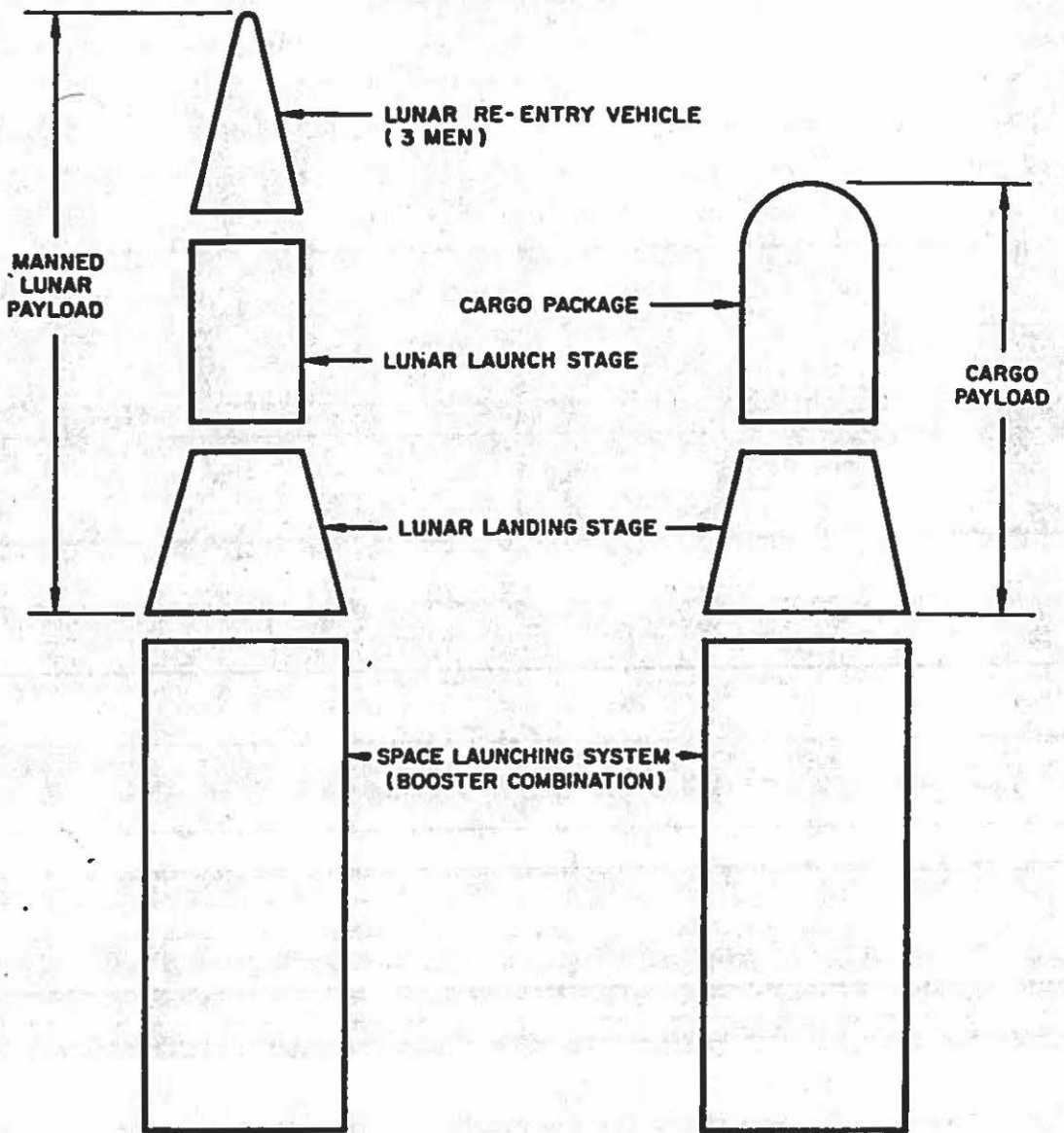


FIGURE 2-2 LUNAR TRANSPORT VEHICLE

[REDACTED]

are being examined. Use of these techniques would require the launch, rendezvous and orbital assembly of sections of the Manned Lunar Payload and the Cargo Payload along with the required orbital launch booster and its fuel. The assembled vehicle would then be boosted from orbital velocity to escape velocity and would proceed as described above. Details of the major developments required such as rendezvous, docking and orbital assembly are outlined in a System Package Plan titled, SAINT being prepared concurrently. All programming information and schedules have been coordinated with this plan to insure compatibility and mutual support.

2.3 DESIGN PHILOSOPHY

The Lunar Expedition Plan has been oriented toward the development of a useful capability rather than the accomplishment of a difficult task on a one-time basis. The use of a large booster is favored for the direct shot approach since studies have shown this to be more reliable, safer and more economical as well as having earlier availability. However, another approach using a smaller booster in conjunction with orbital rendezvous and assembly is also considered.

The manned Lunex Re-entry Vehicle is the key item in determining booster sizes. Its weight determined the size of the Lunar Launch Stage which in turn determined the size of the Lunar Landing Stage. The total weight of these three items is the amount that must be boosted to earth escape velocity by the Space Launching System. In this manner the size of the Space Launching System was determined.

A 2½ day trajectory each way was selected as a conservative design objective. Longer flights would have more life support and guidance problems while shorter flights require higher boost velocity.

An abort capability will be included in the design insofar as possible. The next section describes the abort system in considerable detail.

Development and tests are scheduled on a high priority basis. Thus, the schedules shown in this plan are dictated by technological limitations and not by funds.

The entire program as described herein is an integrated program in that later development tests build on the results of early tests. Thus, equipment and techniques are proved out early, and confidence in the reliability is obtained by the time a man is included.

2.4 ABORT PHILOSOPHY

The insertion of a man into a space system creates a safety and reliability problem appreciably greater than the problem faced by

[REDACTED]

any unmanned system. It is well recognized that maximum reliability is desirable, but also known that reliabilities in excess of 85 to 90% are extremely difficult to achieve with systems as complex as the Lunar Transportation System. Therefore, the need for an abort system to protect the man during the "unreliable" portions of the lunar mission is accepted.

A review of the proposed techniques and equipments to provide a "full abort" capability has shown that due to payload limitations this is not practical during the early lunar missions. Thus a reasonable element of risk will be involved. In order to decrease this element of risk and to understand where it occurs the lunar mission has been divided into six time periods. These time periods are as follows:

- a. Earth ascent.
- b. Earth-moon transit.
- c. Lunar terminal.
- d. Lunar ascent.
- e. Moon-earth transit.
- f. Re-entry.

The development and test philosophy for this program is to launch the manned systems as early as possible in the program, but in an unmanned status. This will provide experience and allow the system to be checked out and "man-rated" before the first manned flight. It also means that the Lunex Re-entry Vehicle will be used for orbital and circumlunar flights prior to the lunar landing and return flight. The propulsion systems used for these early flights will be used throughout the program and the experience gained from each flight will increase the probability of success in reaching the final lunar landing and return objective. Also these propulsion systems will be used concurrently in other programs and at the time of man-rating will possess greater launch experience than can be expected for the largest booster of the Space Launching System. This would indicate that a larger number of unmanned flights should be scheduled for the larger full boost system than for the early flights. It also points out the need for a sophisticated Earth Ascent Abort capability during the first manned lunar landing and return flight.

[REDACTED]

In providing an abort philosophy for the Lunar Program it should be noted that the Lunex Re-entry Vehicle, the Lunar Landing Stage and the Lunar Launching Stage all possess inherent abort capability if utilized properly during an emergency. With sufficient velocity the re-entry vehicle is capable of appreciable maneuvering and landing control to provide its own recovery system. The Lunar Launching and Lunar Landing Stages possess an appreciable Δv capability that can be used to alter the payload trajectory to better accomplish recovery of the man. However, in either case the maneuvers will have to rely on computing techniques to select the best possible abort solution for any specific situation.

With this background, and with the understanding that in a future final design effort "full abort" may be required, the following abort design objectives for the Manned Lunar Payload are presented:

a. Earth Ascent Phase

(1) On Pad.

Full abort system will be provided.

(2) Lift-off to Flight Velocity for the Re-entry Vehicle.

Full abort system will be provided.

(3) Flight Velocity for the Re-entry Vehicle to Escape Velocity.

The basic Manned Lunar Payload will provide the abort capability.

b. Earth-Moon Transit

(1) Injection

Abort capability to compensate for injection error is desired as part of the basic Manned Lunar Payload. Computing, propulsion, etc., capabilities should be designed into the basic system to provide for the selection of the optimum abort trajectory.

[REDACTED]

(2) Mid-course

Abort capability during Earth-Moon transit is desired for the Re-Entry Vehicle by means of a direct earth return, earth orbit, or circumlunar flight and earth return. Circumlunar flight generally requires the least Δv , but the actual selection of the optimum trajectory should be accomplished when required by a computing capability, and executed by the Lunar Payload.

c. Lunar Terminal

This type of abort generally results from loss of propulsion or control of the Lunar Landing Stage. Where possible the Lunar Launching Stage will be used to attain a direct or circumlunar trajectory that terminated in an earth return. When this is not possible the Lunar Launching Stage will be used to accomplish the safest possible lunar landing. Recovery of the crew will not be provided in this system and selection of the above alternatives will be accomplished automatically on-board. Crew recovery will be provided by another stand-by Lunar Transport Vehicle.

d. Lunar Ascent

Maximum inherent reliability by overdesign of components and systems in the Lunar Launching Stage seems to be the most logical approach for this phase due to the extreme weight penalty imposed by a separate abort system.

The early missions will be faced with the highest risk, but as a facility on the lunar surface is developed, a rescue capability and the addition of an abort capability can be developed. No specific abort system will be provided for this phase, but consideration should be given to the possibility of future lunar modifications to provide for abort.

e. Moon-Earth Transit

This would generally be associated with a gross trajectory error, or loss of control on re-entry. The only solution is to utilize the on-board capability that remains to achieve an earth orbit. After achieving orbit an earth launched rescue mission would be initiated. This approach requires no additional abort system to be provided for this phase.

f. Re-entry

Exceeding re-entry corridor limits, or loss of control could cause an emergency where abort would be desirable. Should sufficient Δv remain from the over-design of the lunar launch stage, and not be used during Moon-Earth transit this would be used to attain an earth orbit where rescue could be achieved. No separate abort capability is required for this phase, but availability of propellant should be considered.

2.5 EXPEDITION PLANNING

A detailed plan must be prepared for the complete Lunar Expedition operation. This plan must start from the first time man lands on the lunar surface and account for every single effort, or objective he is to accomplish during his stay on the surface. A crew of three men will be sent into a new and hostile environment where rescue or assistance from other human beings will be extremely difficult, if not impossible, for the first mission. Time will be at a premium and all items of equipment must be planned, designed and delivered in the Cargo Payloads so that they can be used in the easiest possible manner.

The procedures for first exploring the surface and then for constructing the expedition facility must all be derived, demonstrated and proven by earth operations prior to attempting the desired operation on the moon. An environmental facility that simulates the lunar surface with sufficient work area to test out equipment and procedures will be required.

The actual landing operation and the first effort by men on the surface requires detailed data about the moon's surface. The following chart represents the best available data. The chart is a portion of a Lunar Sectional having a scale of 1:1,000 (1 inch equals 16 miles) produced by the USAF Aeronautical Chart and Information Center, St Louis, Missouri. Present plans call for the eventual production of 144 charts to cover the complete lunar surface.

The best photographic resolution to date is around one-half mile on the lunar surface, which provides adequate data for charts having a scale of 1:1,350,000. Good astronomical telescopes can be used to improve on the photographic data and obtain sufficient detail to prepare sectional charts like the one included. However, larger

[REDACTED]

scale, accurate lunar charts will be required to complete detailed plans. Data can be obtained for such charts from a lunar orbiting photographic satellite which will provide sufficient resolution and overlap to enable stereographic compilation of contours and elevations. The NASA proposed Lunar Orbiter program is a possible source of the required data.

Planning for construction of the expedition facility can begin only after detailed surface information becomes available. Examination of returned lunar core samples will be necessary before plans can be completed.

2.12

WDLAR-S-458

USAF LUNAR CHART

SCALE 1:1,000,000

PUBLISHED BY THE AERONAUTICAL CHART AND INFORMATION CENTER
UNITED STATES AIR FORCE
ST. LOUIS 18 MO



KEPLER LAC 57

Mercator Projection
Scale 1:1,000,000 at 11°00'45"

1ST EDITION DECEMBER 1960

NOTES

This chart was prepared with advisory assistance from Dr. G. P. Kuiper and his collaborators, D. W. G. Arthur and E. A. Whitaker.

CONTROL

The position of features on this chart was determined through the use of selenographic control established primarily from the measures of J. Franz and S. A. Saunder. A collated listing of this control was published under the auspices of the International Astronomical Union in 1935. (Named Lunar Formations - Blagg and Müller).

VERTICAL DATUM

Vertical datum is based on an assumed spherical figure of the moon and a lunar radius of 1738 kilometers. The datum plane was subsequently adjusted to 2.6 kilometers below the surface described by the 1738 kilometer radius to minimize the extent of lunar surface of minus elevation value. Gradients of major surface undulations were established by interpolating Schrutka - Rechtenstamm computations of J. Franz's measurements of 150 moon craters. The probable error of comparative elevation values is evaluated at 1000 meters. Vertical datum, so established, is considered interim and will be refined as soon as an accurate figure of the moon is determined.

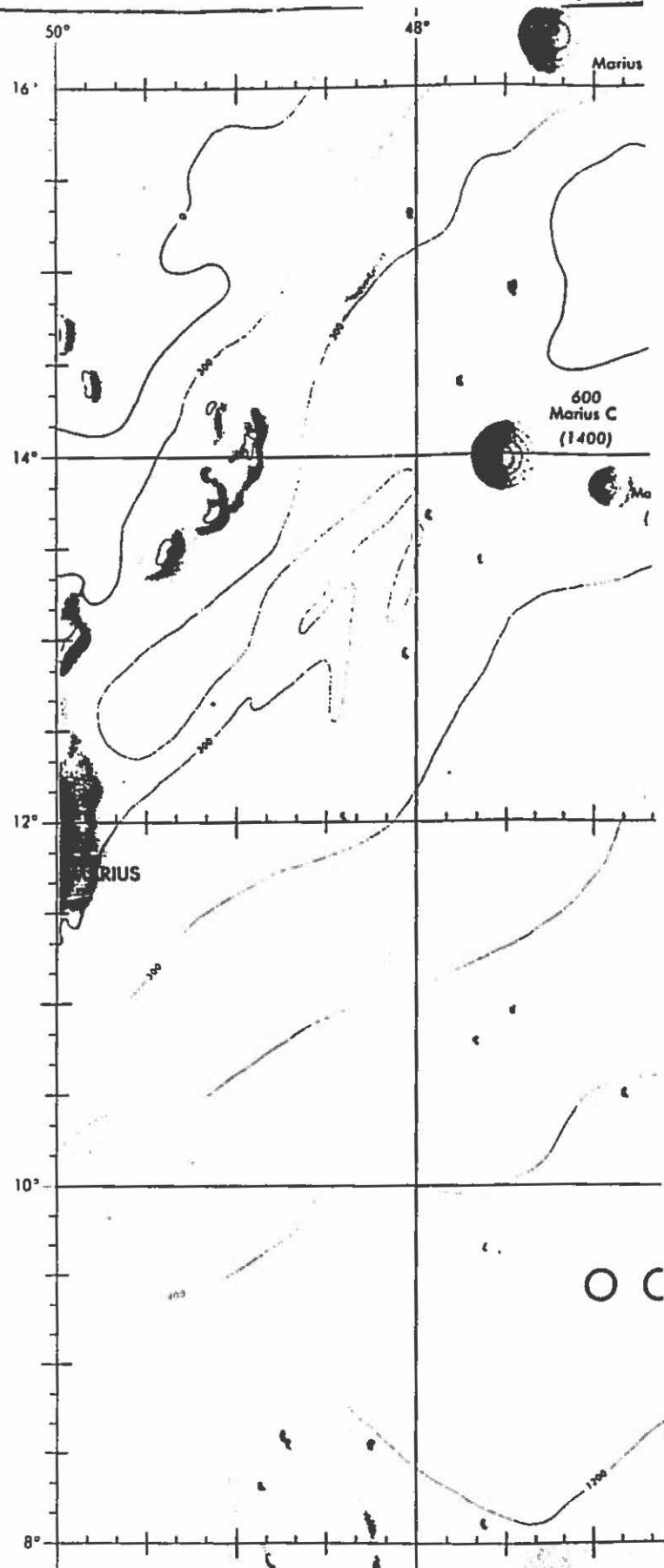
ELEVATIONS

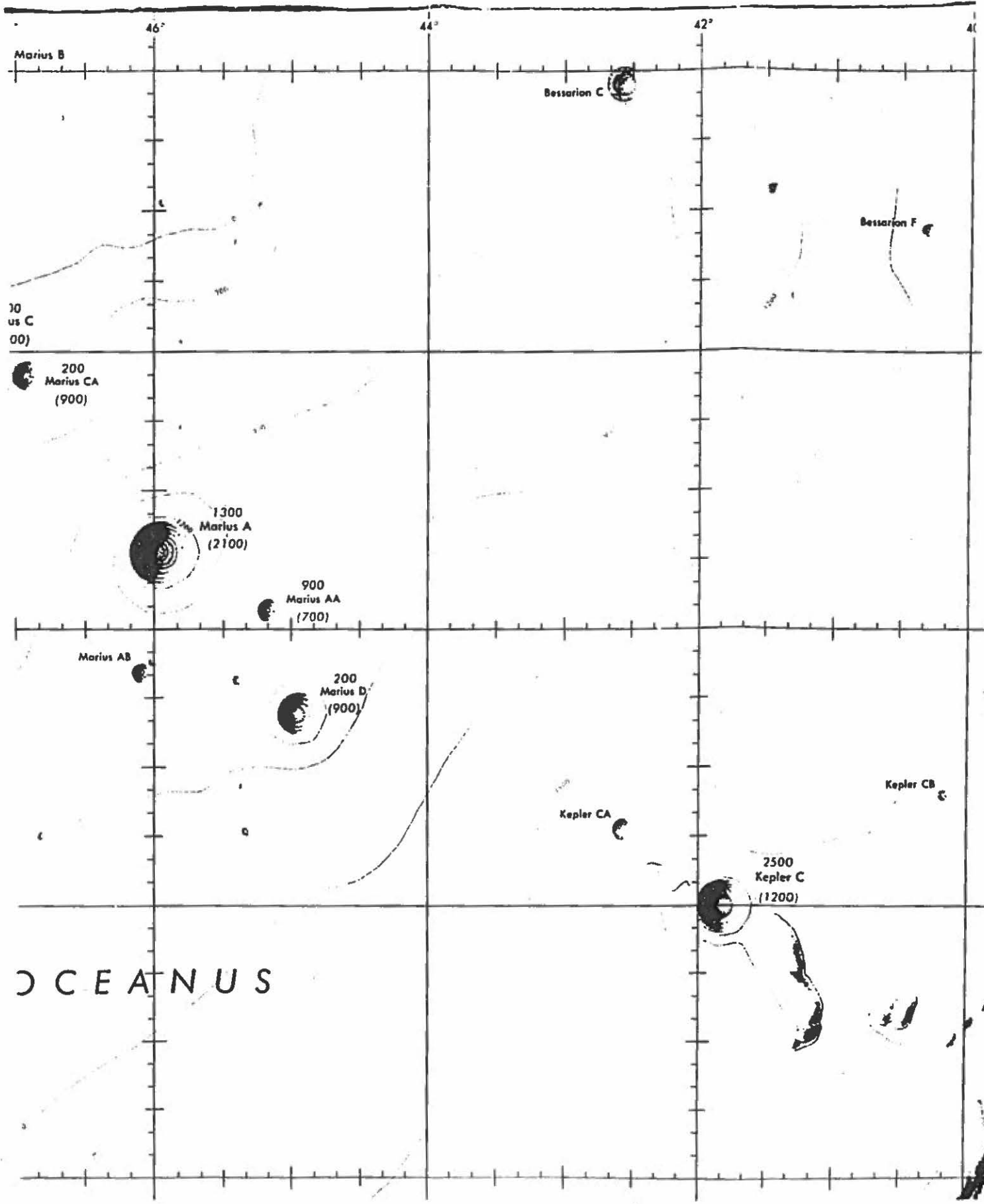
All elevations are shown in meters. The relative heights of crater rims and other prominences above the maria and depths of craters were determined through photographic measurement utilizing the Z. Kopal and G. Fielder Shadow Progression Technique. Relative heights thus established, have been referenced to the assumed vertical datum and have been integrated with the gradients of the surface undulations. The probable error of the localized relative heights is 100 meters. Inherent with measuring technique used, relative height determinations in general E-W direction are more accurate than in the N-S direction.

Spot Elevation (referenced to datum)..... 100
Crater Elevations
Rim (referenced to Datum)..... 100
Depth of crater (rim to floor)..... 100

CONTOURS

All contours are approximate
Contour interval is 300 meters
Contour interval 150 meter contours are shown in blue





Marius B

Bessarion C

Bessarion F

30
us C
00)

200
Marius CA
(900)

1300
Marius A
(2100)

900
Marius AA
(700)

Marius AB

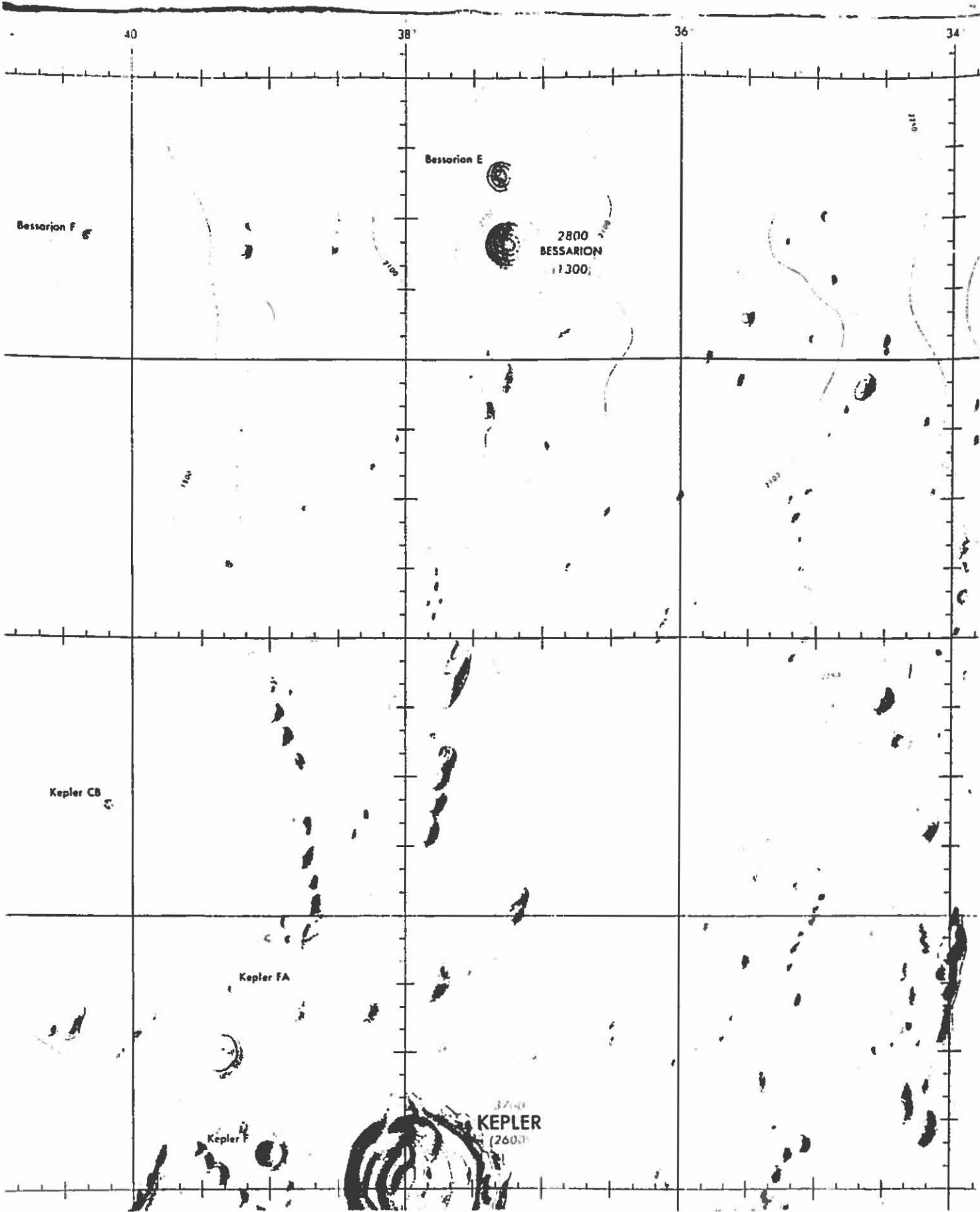
200
Marius D
(900)

Kepler CA

Kepler CB

2500
Kepler C
(1200)

OCEANUS





USAF LUNAR CHART

SCALE 1:1,000,000

PUBLISHED BY THE AERONAUTICAL CHART AND INFORMATION CENTER
UNITED STATES AIR FORCE
ST. LOUIS 18 MO



KEPLER

LAC 57

Mercator Projection
Scale 1:1,000,000 at 11°00'45"

1ST EDITION DECEMBER 1960

NOTES

This chart was prepared with advisory assistance from Dr. G. P. Kuiper and his collaborators, D. W. G. Arthur and E. A. Whitaker.

CONTROL

The position of features on this chart was determined through the use of selenographic control established primarily from the measures of J. Franz and S. A. Saunder. A cataloged listing of this control was published under the auspices of the International Astronomical Union in 1935. (Named Lunar Formations - Blagg and Müller).

VERTICAL DATUM

Vertical datum is based on an assumed spherical figure of the moon and a lunar radius of 1738 kilometers. The datum plane was subsequently adjusted to 2.6 kilometers below the surface described by the 1738 kilometer radius to minimize the extent of lunar surface of minus elevation value. Gradients of major surface undulations were established by interpolating Schrutka - Rechtenstamm computations of J. Franz's measurements of 150 moon craters. The probable error of comparative elevation values is evaluated at 1000 meters. Vertical datum, so established, is considered interim and will be refined as soon as an accurate figure of the moon is determined.

ELEVATIONS

All elevations are shown in meters. The relative heights of crater rims and other prominences above the maria and depths of craters were determined through photographic measurement utilizing the Z. Kopal and G. Fielder Shadow Progression Technique. Relative heights thus established, have been referenced to the assumed vertical datum and have been integrated with the gradients of the surface undulations. The probable error of the localized relative heights is 100 meters. Inherent with measuring technique used, relative height determinations in general E-W direction are more accurate than in the N-S direction.

Spot Elevation (referenced to datum)..... 1400

Crater Elevations

Rim (referenced to Datum)..... 300

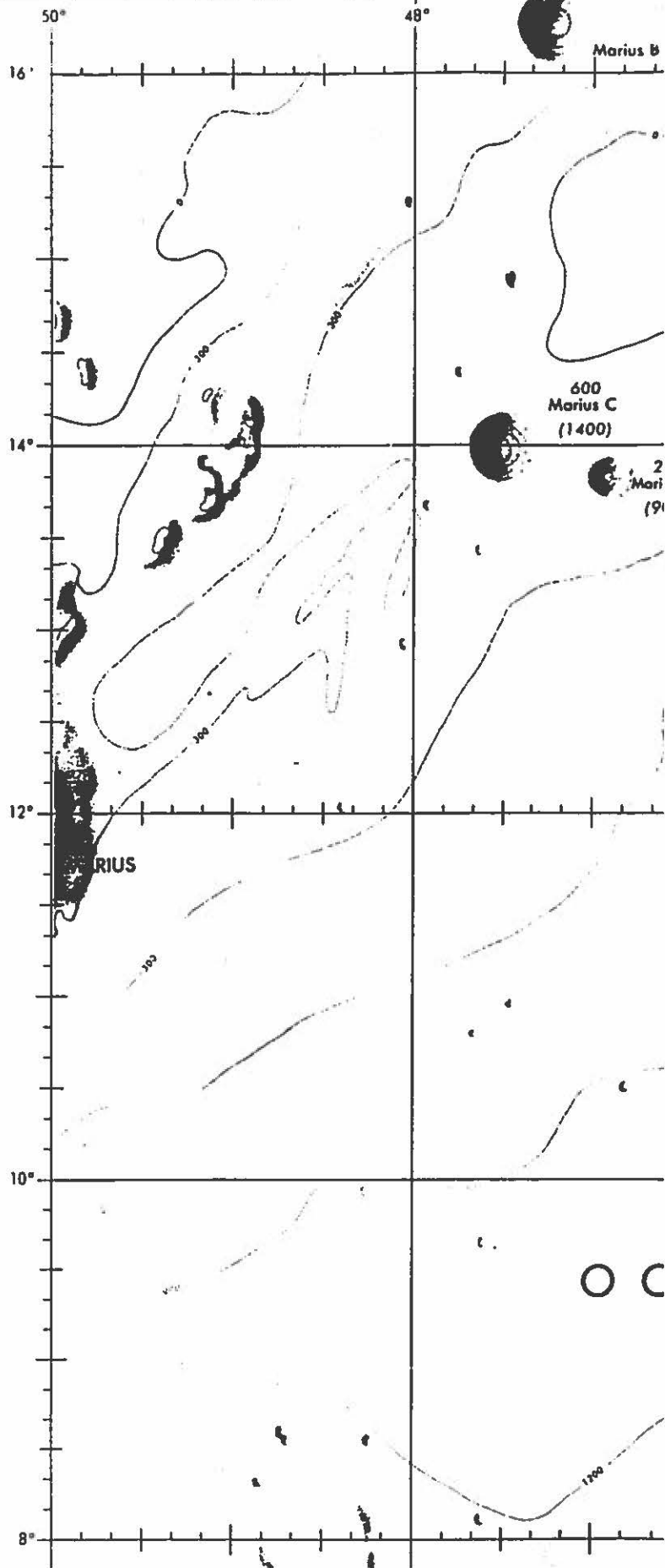
Depth of crater (rim to floor)..... 1400

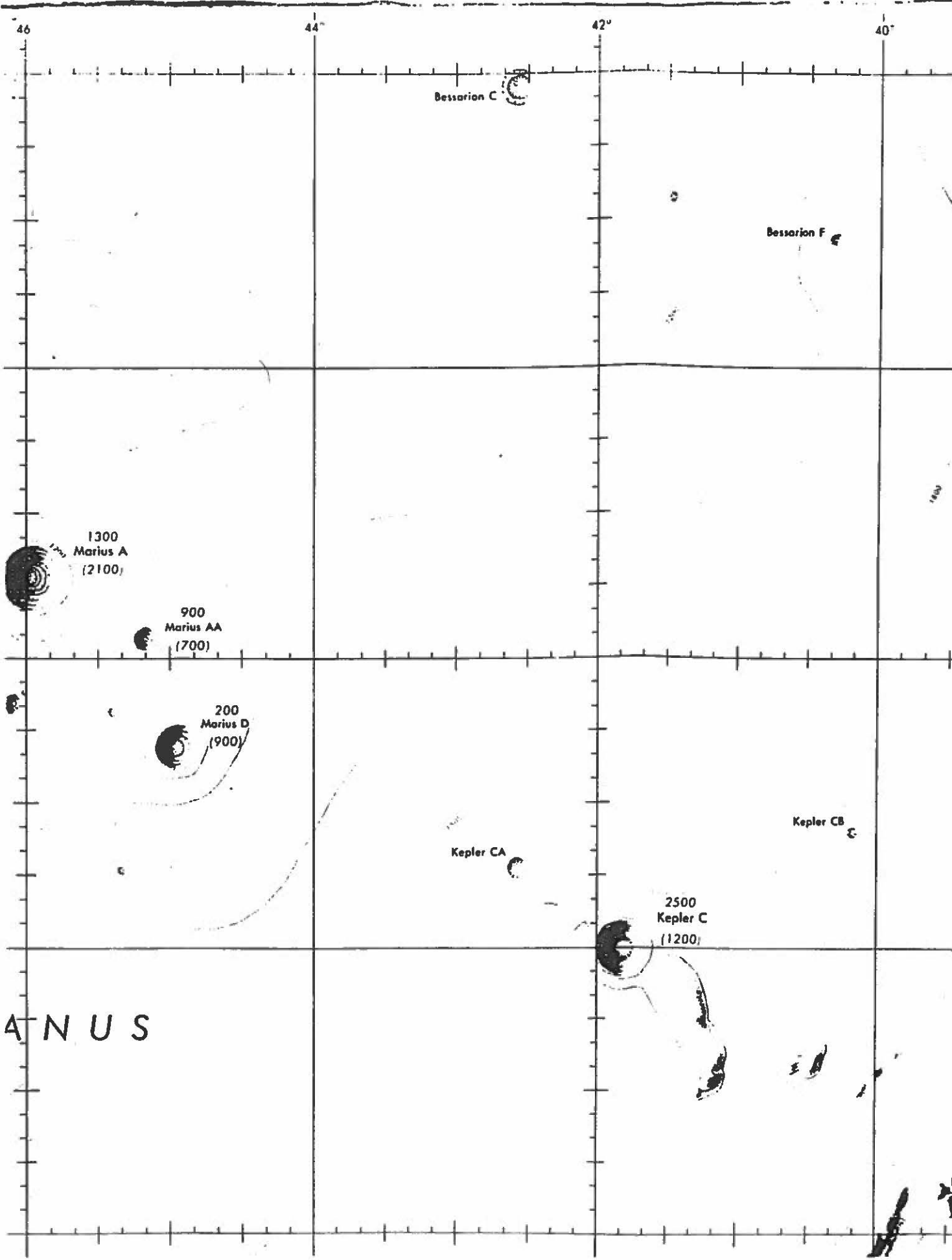
CONTOURS

All contours are approximate

Contour interval is 300 meters

Spot elevations, 150 meter contours are shown in blue





A N U S

40

38

36

Bessaron F

Bessaron E

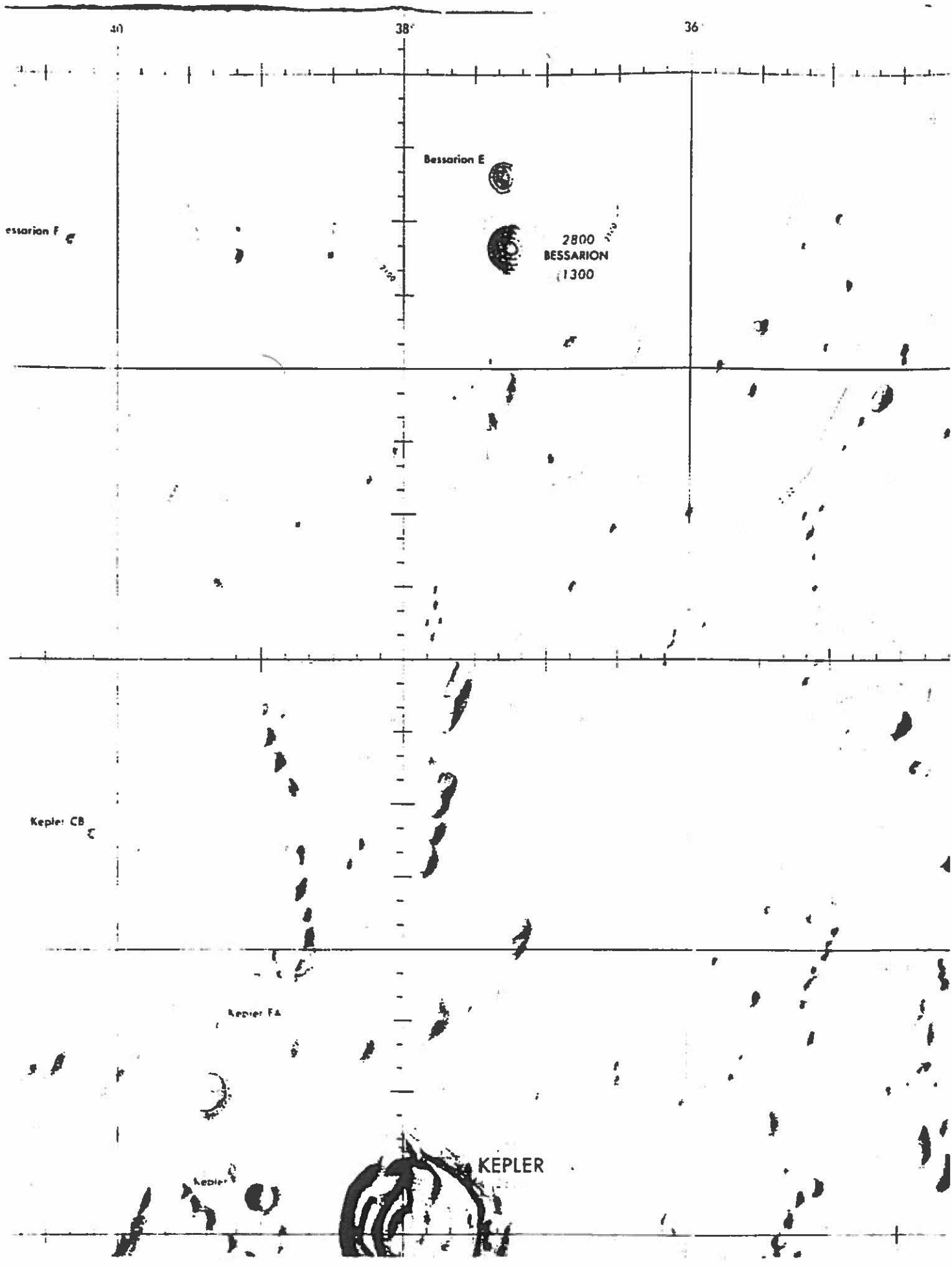
2800
BESSARION
1300

Kepler CB

Kepler FA

Kepler

KEPLER



36

34

32°

30°

1800
TOBIAS MEYER

(2400)

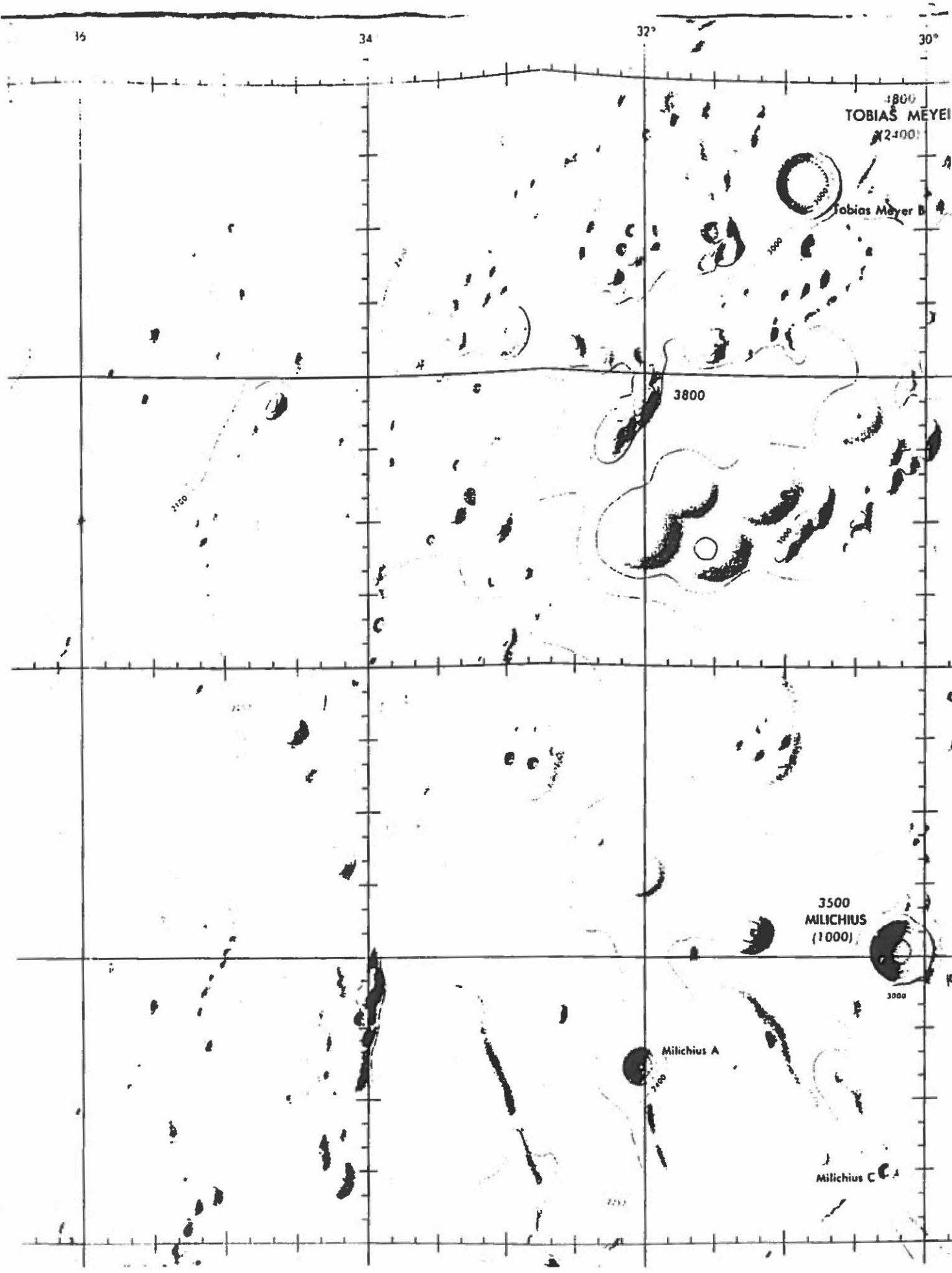
Tobias Meyer B

3800

3500
MILICHUS
(1000)

Milichius A

Milichius C





SECTION III

MASTER SCHEDULES

LUNAR EXPEDITION (U)

(LUNEX)





RECORD OF CHANGES

CHANGE NO.	DESCRIPTION OF CHANGE	DATE OF CHANGE	REFERENCE TO BASIC PART

3.2

WDLAR-S-458





INDEX

TITLE PAGE	3.1
RECORD OF CHANGES	3.2
INDEX	3.3
3.0 INTRODUCTION	3.5
3.1 MASTER PROGRAM PHASING CHART	3.5
3.2 LUNAR EXPEDITION PROGRAM SCHEDULE	3.6
3.3 LUNAR EXPEDITION MANAGEMENT MILESTONES FY62-FY63	3.6
3.4 LUNAR EXPEDITION TEST SCHEDULE	3.7
3.5 LUNEX SPACE LAUNCHING REQUIREMENTS	3.7
3.6 PERSONNEL AND TRAINING	3.8
3.7 LUNEX CIVIL ENGINEERING FACILITIES SCHEDULE	3.8
ATTACHMENTS	
III - A LUNAR EXPEDITION MASTER PROGRAM SCHEDULE	
III - B LUNAR EXPEDITION PROGRAM SCHEDULE	
III - C LUNAR EXPEDITION MANAGEMENT MILESTONES FY62-FY63	
III - D LUNAR EXPEDITION TEST SCHEDULE	
III - E LUNEX SPACE LAUNCHING REQUIREMENTS	
III - F LUNEX CIVIL ENGINEERING FACILITIES DEVELOPMENT PROGRAM	
III - G LUNEX TRAINING SCHEDULE	





This page intentionally left blank

3.4

WDLAR-S-458



[REDACTED]

3.0 INTRODUCTION

The establishment of the Lunar Expedition Program as a National objective will provide a worthy goal for the United States industrial and governmental organizations. The Lunar Expedition program has been based on extensive study, design and research work during the past three years.

A Lunar Expedition program will require the use and centralized control of a major portion of the present military space capability. This will have the effect of giving the military program a scheduled long-range objective, and still provide useable military capabilities throughout the period. As an example, manned re-entry vehicles for orbital operations will be available in early 1965. This will be followed by a manned lunar re-entry vehicle in 1966.

Propulsion and Space Launching systems will be required to support the LUNEX program. This program will set orbital and escape velocity payload requirements ranging from 20 to 350 thousand pounds in a 300 mile orbit and from 24,000 to 134,000 pounds at escape velocity. This capability will be obtained at an accelerated pace for the LUNEX program and as a result the same capabilities will be available for military use much earlier than could be achieved if the start of the development programs had to be justified at this time entirely on the basis of military usefulness.

The accomplishment of the LUNEX program will require maximum use of several presently programmed efforts and reorientation of others. The major programs of direct interest to the Lunex are the SAINT and BOSS programs. Therefore, these efforts have been coordinated and integrated with the LUNEX program. The BOSS shots will provide the necessary orbital primate test data to allow the manned life support package for the Lunex Re-entry Vehicle to be designed. The SAINT unmanned and manned program will provide additional orbital information on rendezvous, docking, and personnel and fuel transfer. In the event that the direct shot approach for the Lunar expedition requires reorientation in future years to use orbital assembly techniques this capability will be available from the SAINT program.

3.1 MASTER PROGRAM PHASING CHART

This schedule presents the integrated military program required to accomplish the Lunar Expedition mission and to develop techniques for operating in the earth orbital and lunar areas. It was prepared to indicate the interface between this Lunar Expedition System Package Plan and the Space Launching System. The major national objective of this integrated program is to land men on the moon and return them in August of 1967.



3.2 LUNAR EXPEDITION PROGRAM SCHEDULE

This schedule presents the major items to be accomplished as a result of the LUNEX program. The costing as shown on the schedule does not include the cost of developing the Space Launching System since this is provided under a separate System Package Plan. However, the cost of purchasing the flight vehicles is included.

The major "prestige" milestones of the program can be summarized as follows:

First Manned Orbital Flight (3 Man Space Vehicle)	April 1965
First Lunar Landing (Cargo)	July 1966
Manned Circumlunar Flight	Sept. 1966
Manned Lunar Landing & Return	Aug. 1967
Permanently Manned Lunar Expedition	Jan. 1968

3.3 LUNAR EXPEDITION MANAGEMENT MILESTONES FY62 - FY63

This schedule indicates the major LUNEX program efforts required during fiscal years 1962 and 1963. The time allocation for management and Air Force technical evaluations have been kept to a minimum in order to meet the end objective of "man on the moon" in August 1967.

Several critical major decisions are required and are summarized below:

Program Approval & Funding	July 1961
Development-Production Funding	Dec. 1962
Design Concept Decision	Jan. 1963
Approval for Hardware Go-Ahead	Feb. 1963

Delays in providing the funding indicated, or in receiving notification of decisions required, will have the direct effect of delaying the end objectives. This problem could be effectively solved by a streamlined management structure having a minimum number of reviewing authorities. The present AFSC procedures are a step in the right direction but more direct channels are desirable at the higher command levels.



[REDACTED]

3.4 LUNAR EXPEDITION TEST SCHEDULE

This schedule presents the major test items required for the LUNEX program. Upon completion of the program manned transport and unmanned cargo vehicles will be available to support the Lunar expedition. The cargo vehicle will be capable of transporting approximately 45,000 pound "cargo packages" to the lunar surface for supporting the expedition. This same vehicle would be capable of transporting future military payloads to the lunar surface to support space military operations.

A detailed high-speed re-entry test program and an abort system test program is scheduled to provide basic re-entry data and to insure the safety of the men in the Lunex Re-entry Vehicle.

Prior to the first "manned lunar landing and return" flight, a series of test and check-out flights will be required. These will initially consist of orbital flights, and then very high altitude (50,000 miles or more) elliptical flights for testing the vehicles under re-entry conditions. When these have been completed, the first flights will be made around the moon (circumlunar) and return to an earth base. With a completely man-rated vehicle, and unmanned lunar landing flights completed, man will then make the first landing on the moon for the purpose of selecting a site for the Lunar Expedition Facility.

3.5 LUNEX SPACE LAUNCHING REQUIREMENTS

The purpose of this schedule is to summarize the space launching vehicle requirements and indicate when the launches will be needed.

The THOR-ABLE-STAR boosters will be used for the re-entry test program. The Space Launching System boosters designated as A, AB and BC, and solids as required, will be needed as indicated and their payload capabilities are estimated as follows:

<u>Booster</u>	<u>Payload</u>
A 410	20,000 pounds (300 mile orbit)
AB 825	87,000 pounds (300 mile orbit)
AB 825	24,000 pounds (escape velocity)
BC 2720	134,000 pounds (escape velocity)

3.7

WDIAR-S-458

[REDACTED]



3.6 PERSONNEL AND TRAINING

The Lunar Expedition program will require military personnel and a military training program. Details of this program are presented in Section IX and summarized on the Lunex Training Schedule included in this section.

The number of personnel required will increase from a limited staff in the early Program Office to a total of 6,000 personnel in the active expedition year. This total does not include "in plant" contractor personnel which is estimated to be on the order of 60 thousand.

Training of military personnel to meet the requirements of the LUNEX program will be done by contractor and military training personnel. Maximum use will be made of program equipment when it can be scheduled for training purposes and in addition, allocation of production equipment is necessary to meet training requirements.

3.7 LUNEX CIVIL ENGINEERING FACILITIES SCHEDULE

The facilities development and construction program is shown on this schedule. The first item to be accomplished is a site survey to determine the extent that the LUNEX program can be supported by AMR and PMR. When this has been accomplished it will be possible to determine if the early LUNEX test launches can be accomplished by using present facilities. Full consideration will be given to the possibility of building the Lunex Launch Complex as an expansion of the AMR or PMR. A more detailed presentation of the facilities program is contained in Section VIII Civil Engineering.

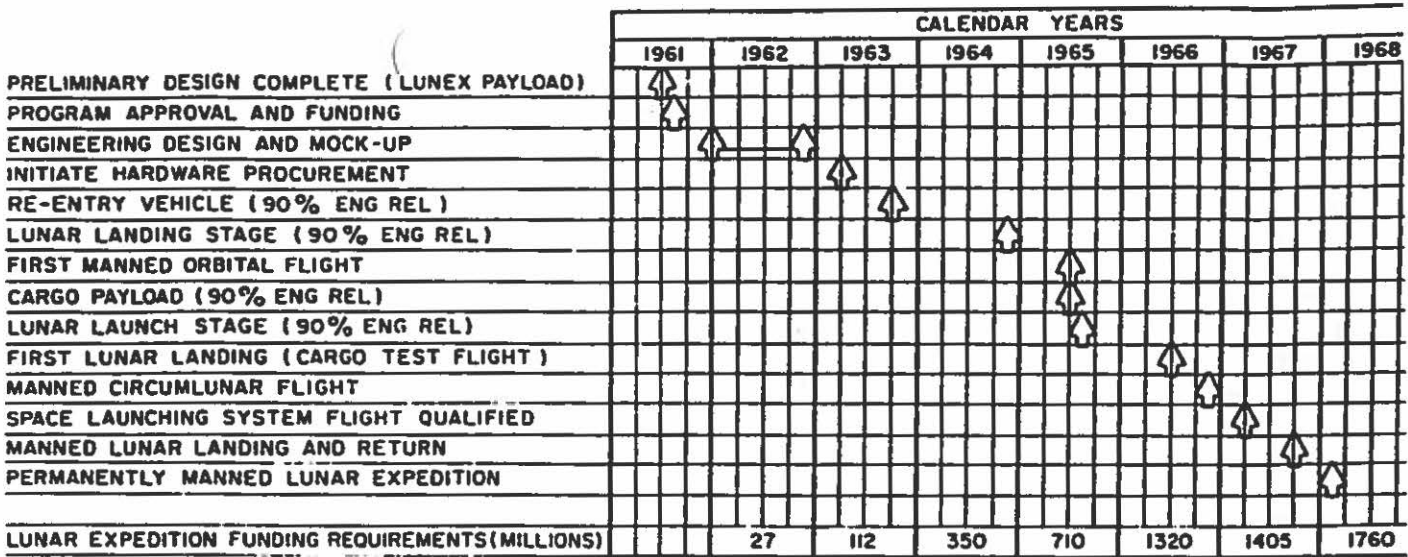
III-A LUNAR EXPEDITION
MASTER PROGRAM SCHEDULE
PROGRAM SCHEDULE

DATE	TOTAL		PRIOR		CY 62												CY 63											
					J	F	M	A	M	J	J	A	S	O	N	D	J	F	M	A	M	J	J	A	S	O	N	D
HIGH SPEED RE-ENTRY TEST																												
BOSS SUPPORT																												
ABORT SYSTEM TESTS																												
ORBITAL																												
UNMANNED																												
MANNED																												
CIRCUMLUNAR																												
UNMANNED																												
MANNED																												
LUNAR LANDING & RETURN																												
UNMANNED																												
MANNED																												
LUNAR EXPEDITION																												
BOOSTER REQUIREMENTS																												
RE-ENTRY TEST																												
A-410																												
AB-825																												
BC-2720																												

J	F	M	A	M	J	J	A	S	O	N	D	J	F	M	A	M	J	J	A	S	O	N	D
FY 62						FY 63																	



CHART III-B
LUNAR EXPEDITION PROGRAM MILESTONE SCHEDULE

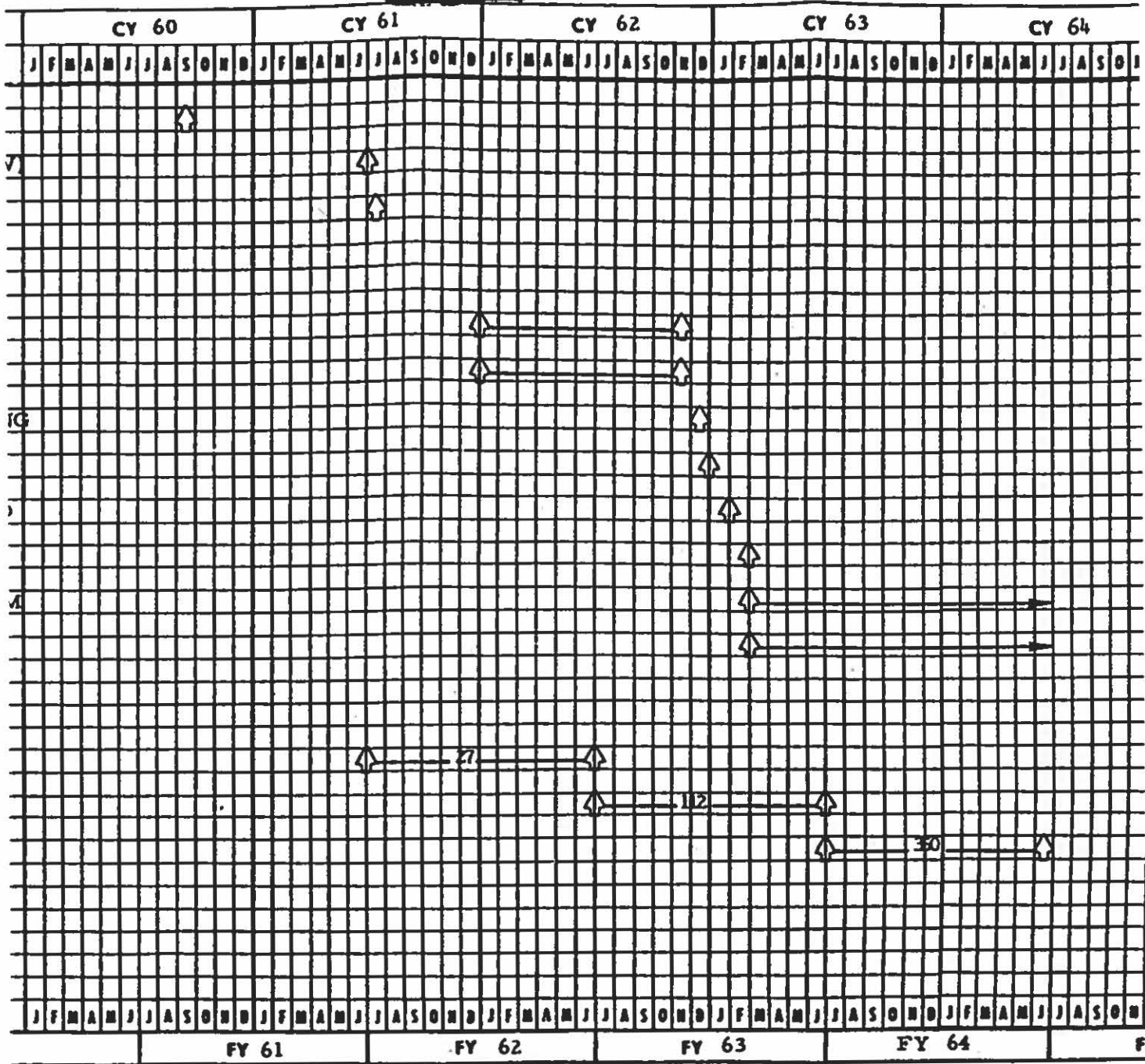


PROGRAM SCHEDULE



III C		LUNAR EXPEDITION.		CY 60												CY 61												CY 62																																							
MANAGEMENT MILESTONES FY62 - FY63				J	F	M	A	M	J	J	A	S	O	N	D	J	F	M	A	M	J	J	A	S	O	N	D	J	F	M	A	M	J	J	A																																
1																																																																			
2	START PRELIMINARY DESIGN (LRV)												▲																																																						
3	COMPLETE PRELIMINARY DESIGN (LRV)																					▲																																													
4	PROGRAM APPROVAL AND FUNDING																					▲																																													
5	ENGINEERING DESIGN COMPETITION AND MOCK-UP																																																																		
6	Contractor No. 1 (Lunex Payloads)																																																																		
7	Contractor No. 2 (Lunex Payloads)																																																																		
8	DEVELOPMENT - PRODUCTION FUNDING																																																																		
9	DESIGN CONCEPT DECISION																																																																		
10	APPROVAL FOR HARDWARE GO-AHEAD																																																																		
11	CONTRACT AWARD																																																																		
12	LUNAR TRANSPORT VEHICLE PROGRAM																																																																		
13	LUNAR EXPEDITION PROGRAM																																																																		
14	REQUIRED FUNDING (MILLIONS)																																																																		
15	FY-62																																																																		
16	FY-63																																																																		
17	FY-64																																																																		
18																																																																			
19	LRV - Lunex Re-entry Vehicle																																																																		
				FY 61												FY 62																																																			

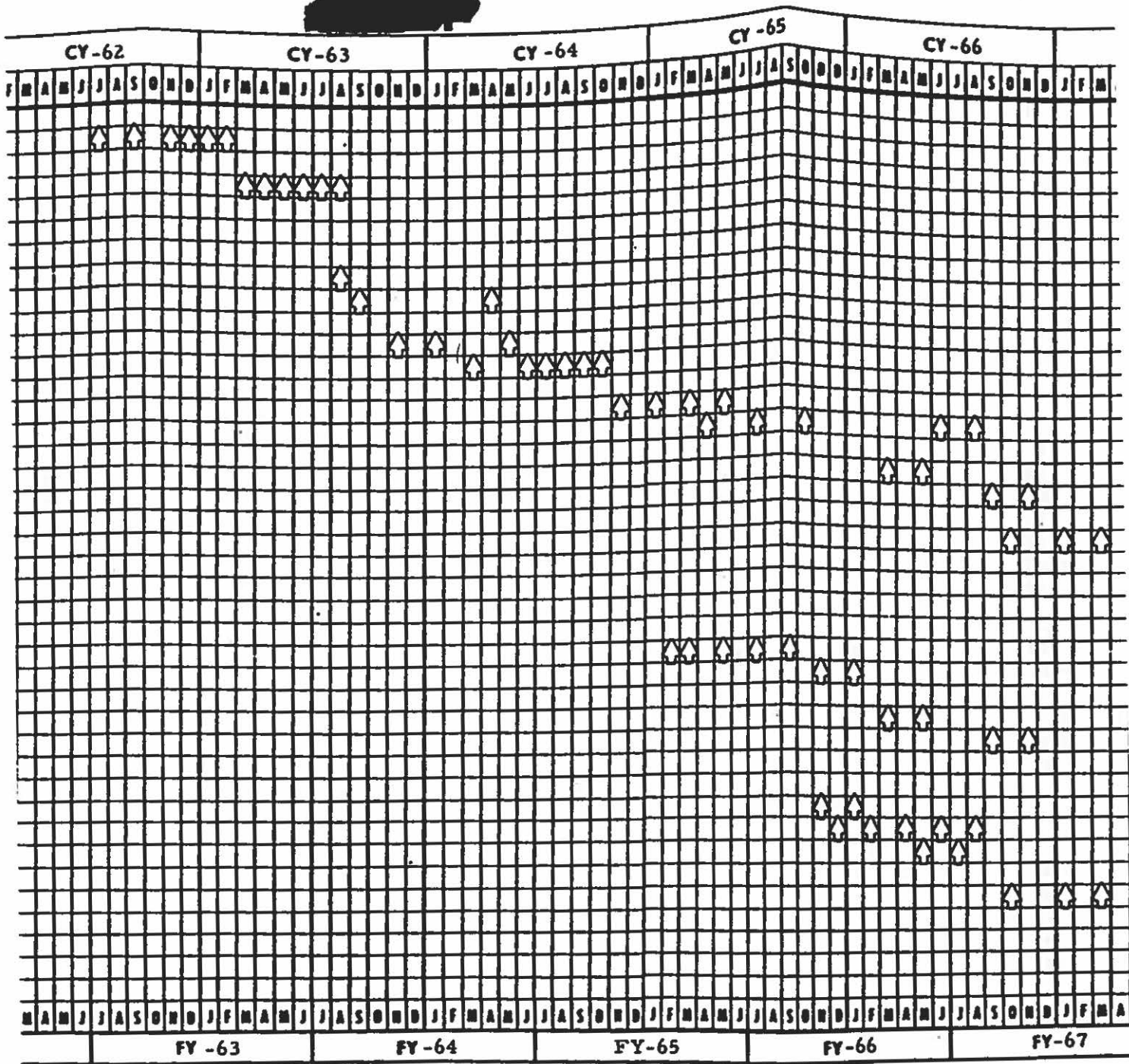




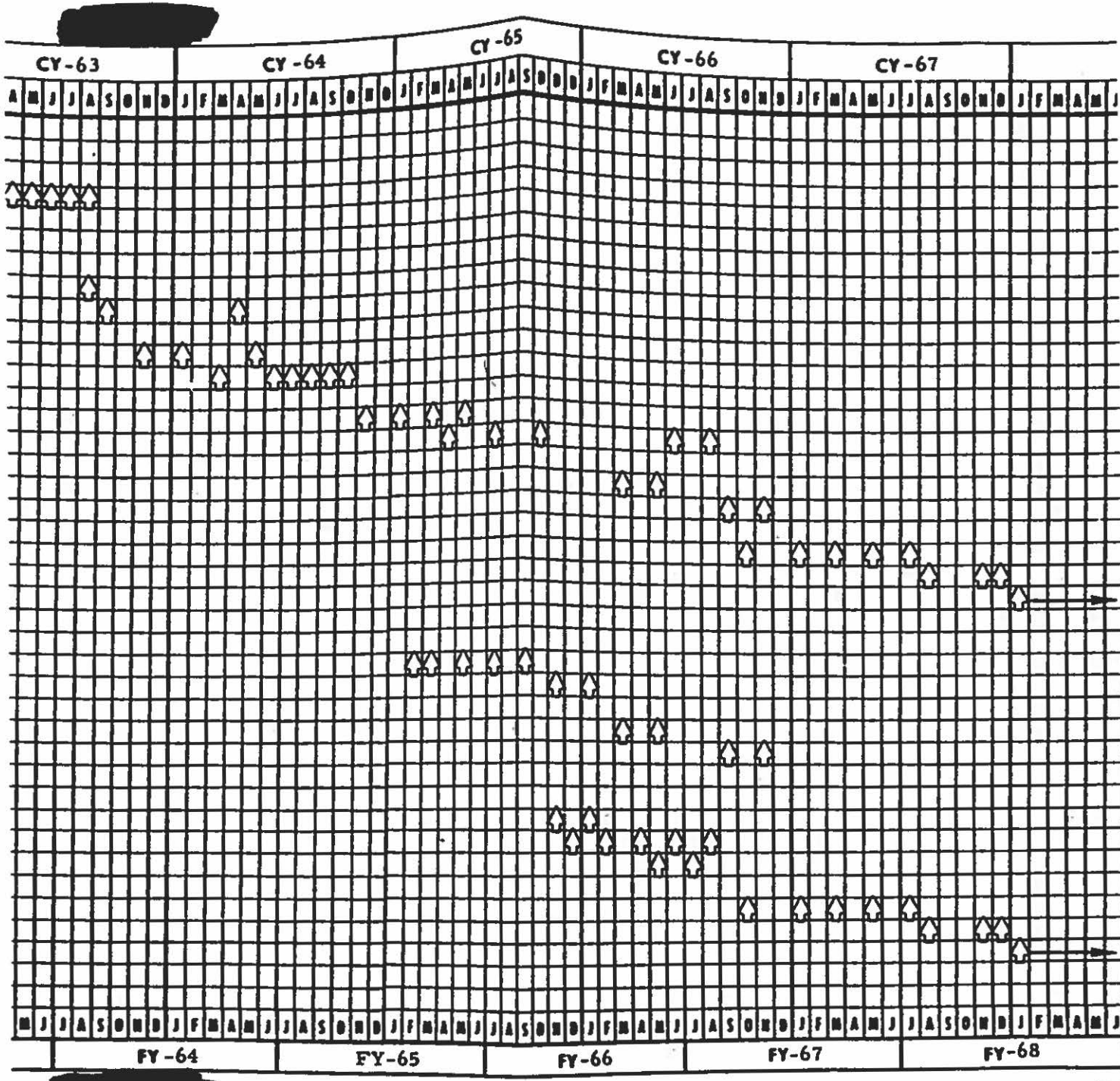
PROGRAM SCHEDULE - 6 Years

III D	LUNAR EXPEDITION	CY-61												CY-62																
		J	F	M	A	M	J	J	A	S	O	N	D	J	F	M	A	M	J	J	A	S	O	N	D	J	F	M	A	
	TEST SCHEDULE																													
1	HIGH SPEED RE-ENTRY TEST																													
2	25,000 - 35,000 ft/sec																													
3	(Sub-Scale)																													
4	35,000 - 45,000 ft/sec																													
5	(Sub-Scale)																													
6																														
7	LUNEX RE-ENTRY VEHICLE																													
8	Static Test																													
9	Eng., Lab., and Gnd. Test																													
10	Prototype Drop Test																													
11	Unmanned																													
12	Manned																													
13	Orbital																													
14	Unmanned																													
15	Manned																													
16	Circum Lunar																													
17	Unmanned																													
18	Manned																													
19	Lunar Landing and Return																													
20	Unmanned																													
21	Manned																													
22	Lunar Expedition																													
23																														
24	CIRCUMLUNAR PROPULSION STAGE																													
25	Eng., Lab., and Gnd. Test																													
26	Orbital Check-out																													
27	Circumlunar																													
28	Unmanned																													
29	Manned																													
30																														
31	LUNAR LAUNCH STAGE																													
32	Eng., Lab., and Gnd. Test																													
33	Earth Launch Test																													
34	Orbital Check-out																													
35	Lunar Launch																													
36	Unmanned																													
37	Manned																													
38	Lunar Expedition																													
39																														
40	(Continued)																													
		J	F	M	A	M	J	J	A	S	O	N	D	J	F	M	A	M	J	J	A	S	O	N	D	J	F	M	A	M
		FY-62												FY-63																

[REDACTED]

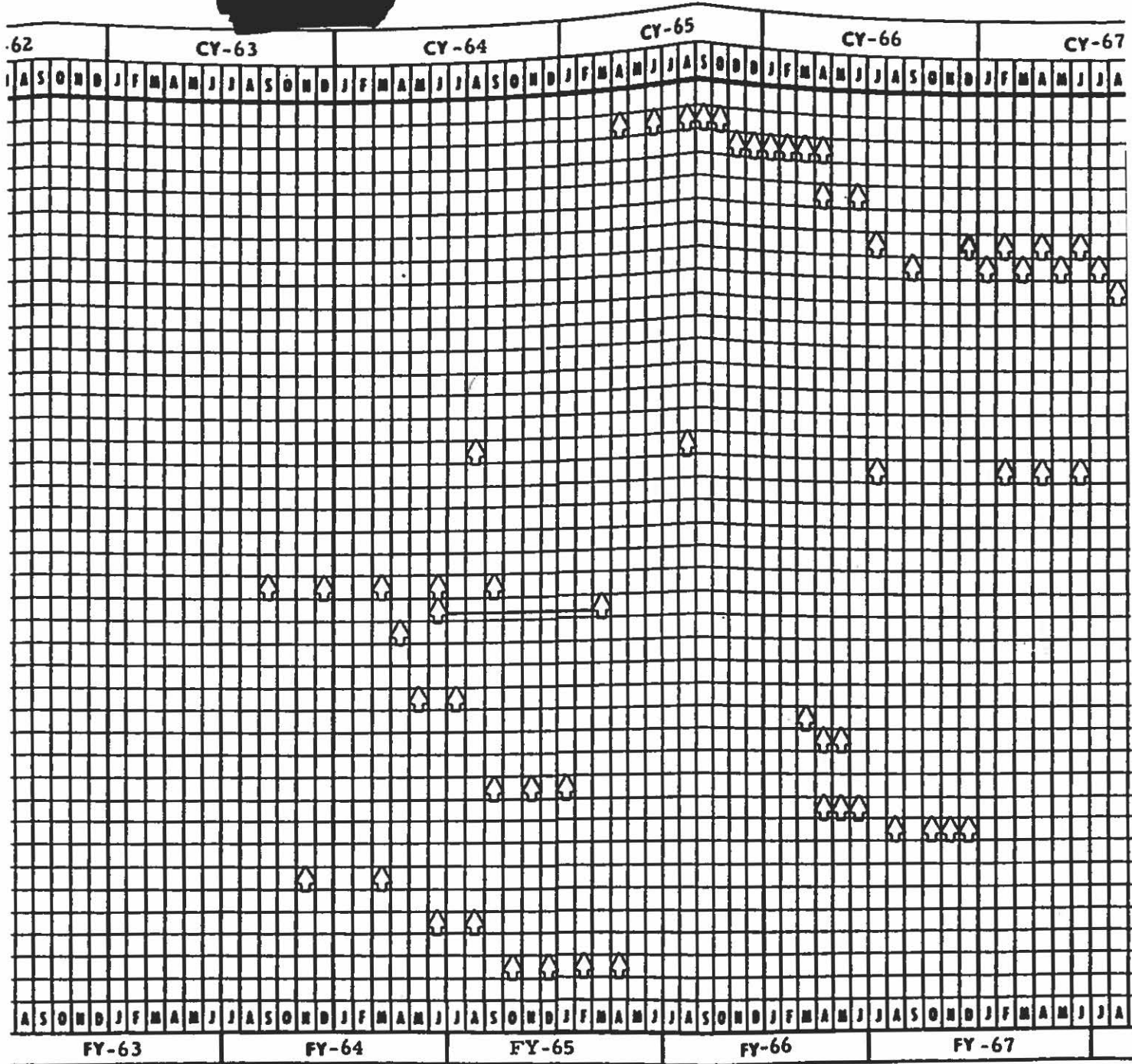


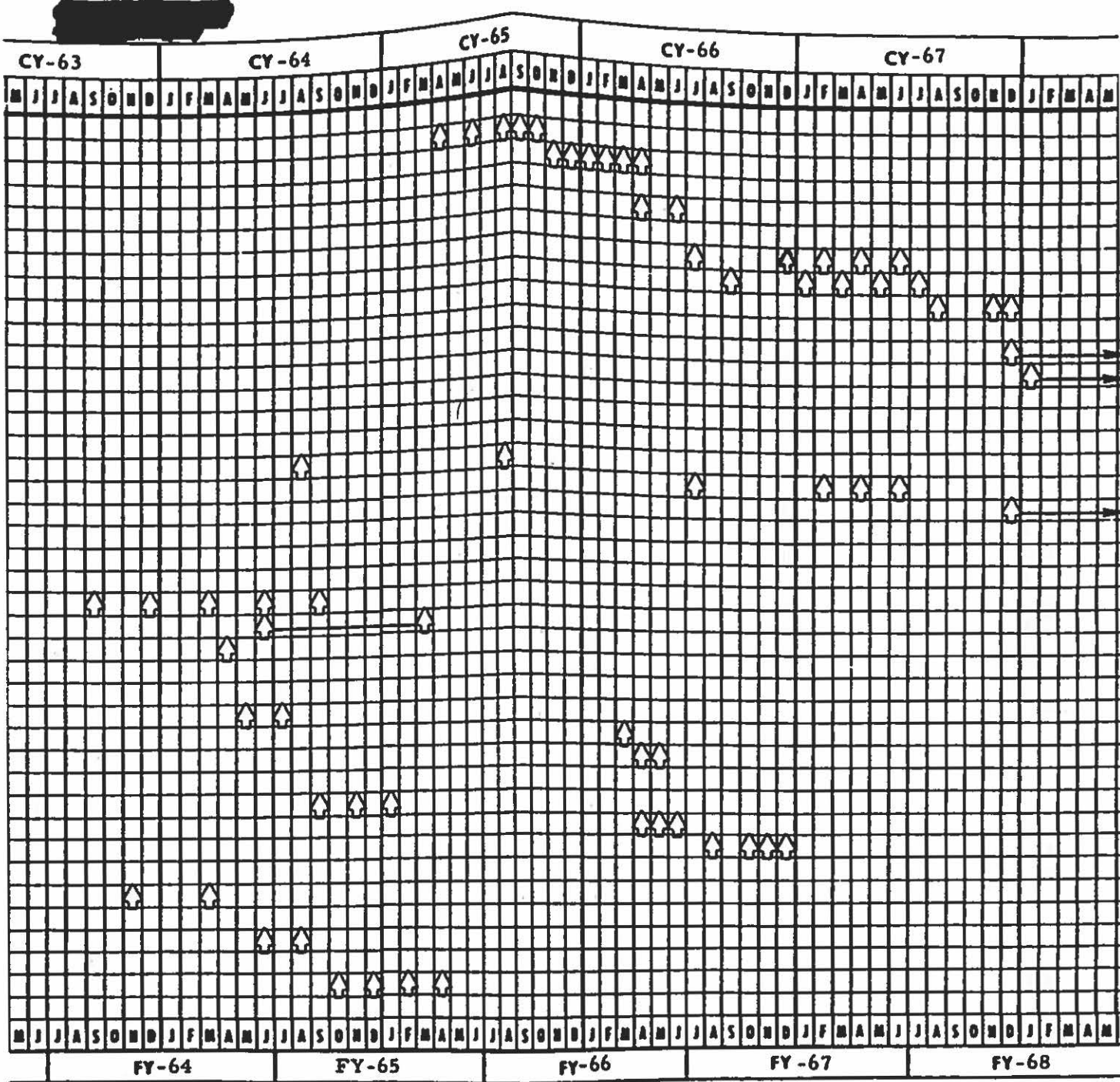
[REDACTED]

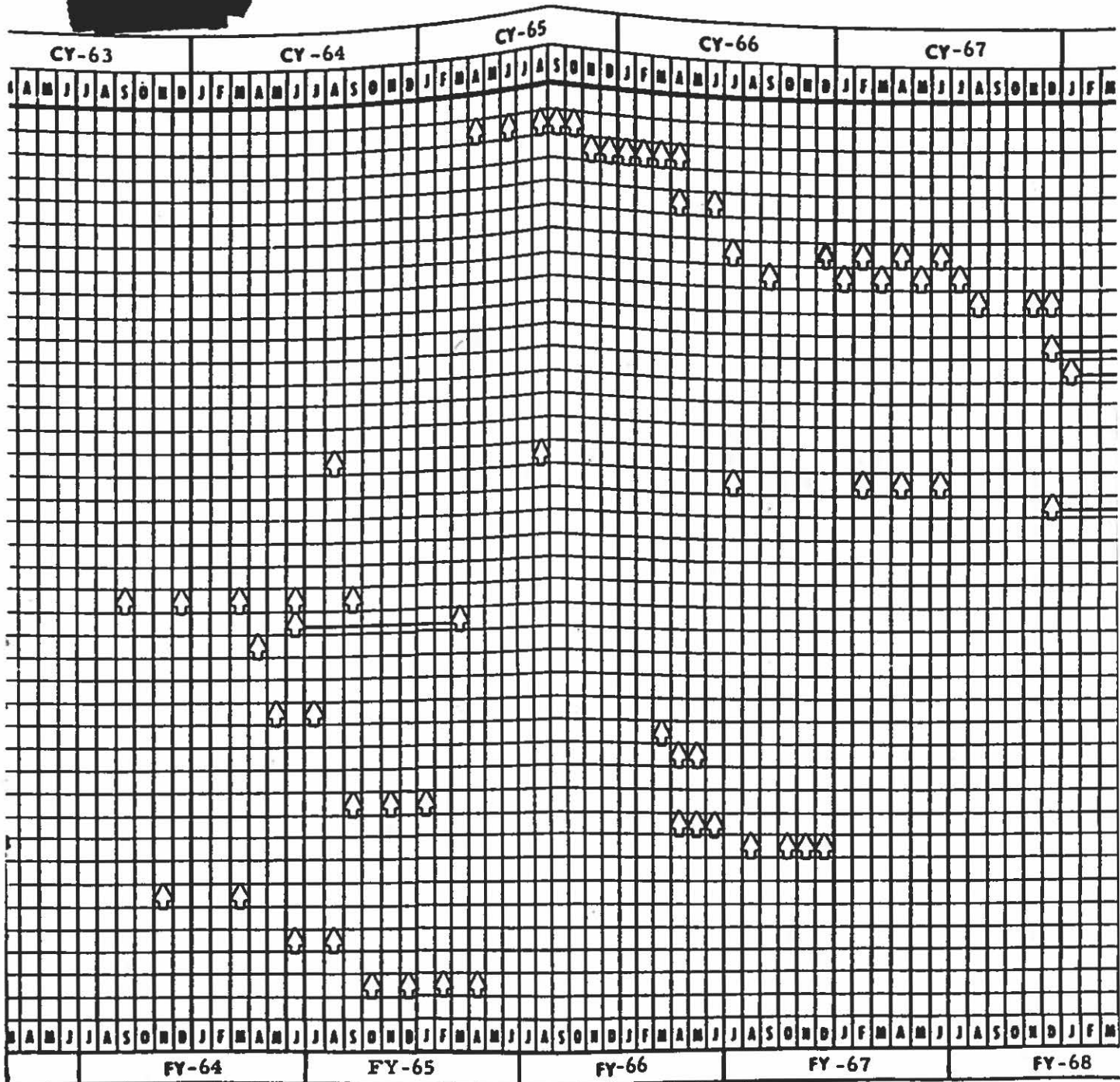


PROGRAM SCHEDULE - 6 Years

III D (Cont.)		CY - 61												CY - 62												C											
LUNAR EXPEDITION		J	F	M	A	M	J	J	A	S	O	N	D	J	F	M	A	M	J	J	A	S	O	N	D	J	F	M	A	M	J						
TEST SCHEDULE																																					
1	LUNAR LANDING STAGE																																				
2	Eng., Lab., and Gnd. Test																																				
3	Drop Test																																				
4	Orbital																																				
5	Cargo																																				
6	Lunar Landing																																				
7	Cargo																																				
8	Unmanned																																				
9	Manned																																				
10	Lunar Expedition																																				
11	Cargo																																				
12	Manned																																				
13																																					
14	CARGO PACKAGE CONFIGURATION																																				
15	Eng., Lab., and Gnd. Test																																				
16	Orbital																																				
17	Lunar Landing																																				
18	Lunar Expedition																																				
19																																					
20	ABORT																																				
21	Auto. Sensing and Initiation Sys.																																				
22	Eng. Lab. Overstress Tests																																				
23	Reliability Demo. Tests																																				
24	Captive Firing Tests																																				
25	Flight Tests																																				
26	Unmanned-Open Loop																																				
27	A-410																																				
28	AB-825																																				
29	BC-2720																																				
30	Unmanned-Closed Loop																																				
31	A-410																																				
32	AB-825																																				
33	BC-2720																																				
34	Abort Vehicle Flight Test																																				
35	Pad Escape																																				
36	Powered Flt. Separation																																				
37	A-X																																				
38	Recovery Ceiling Test																																				
39	A-X																																				
40																																					
		J	F	M	A	M	J	J	A	S	O	N	D	J	F	M	A	M	J	J	A	S	O	N	D	J	F	M	A	M	J						
														FY - 62												FY - 63											







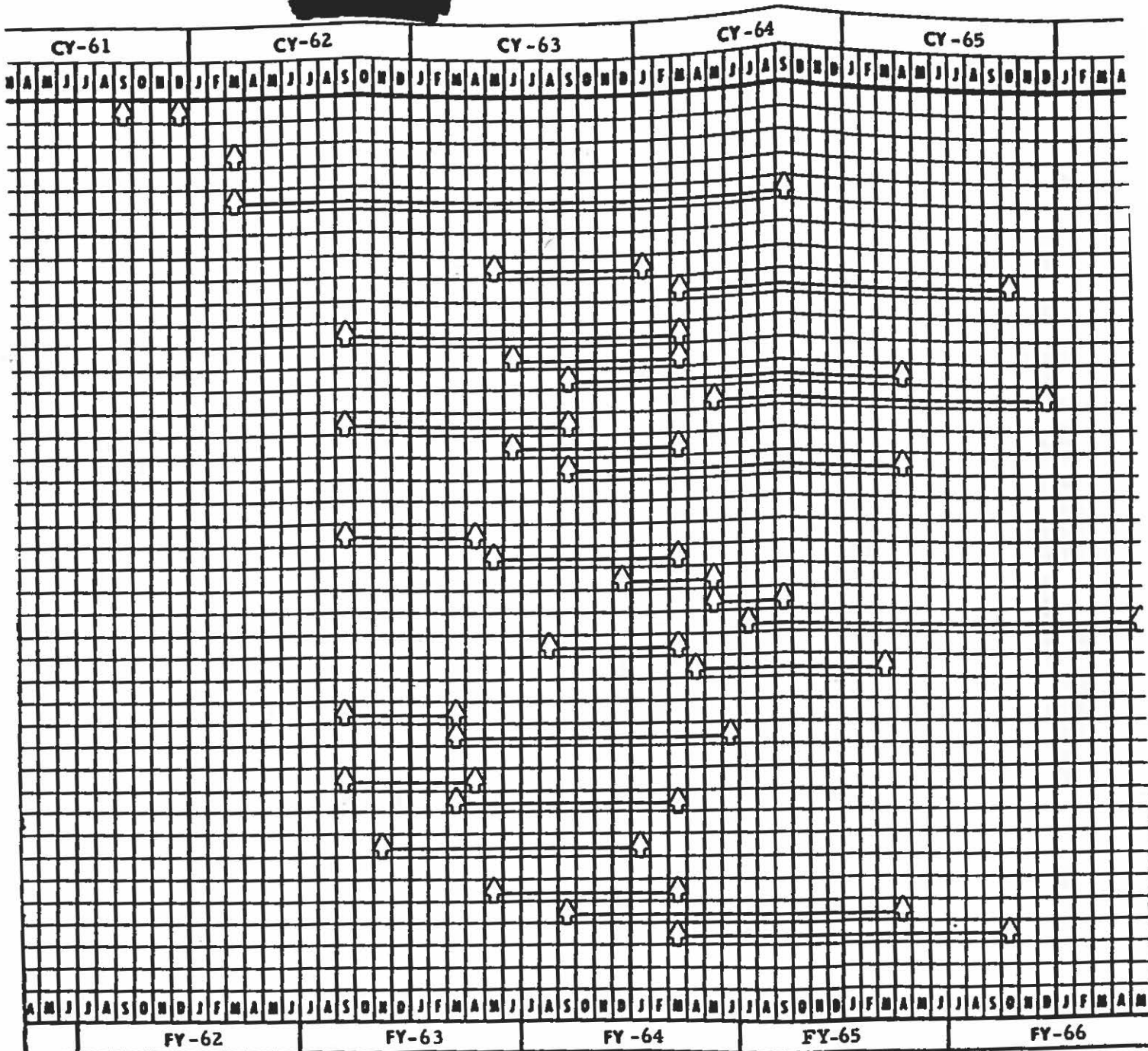
[Redacted]

PROGRAM SCHEDULE - 6 Years

III E	LUNEX SPACE LAUNCHING REQUIREMENTS	CY-61												CY-62												CY				
		J	F	M	A	M	J	J	A	S	O	N	D	J	F	M	A	M	J	J	A	S	O	N	D	J	F	M	A	M
1																														
2	THOR-ABLE-STAR																													
3	Unmanned																			1	2	3	4	5	6	7	8	9	10	
4																														
5																														
6	SPACE LAUNCHING SYSTEM																													
7																														
8	A Unmanned																													
9																														
10	A Man-Rated																													
11																														
12	AB Unmanned																													
13																														
14	BC Unmanned																													
15																														
16	BC Man-Rated																													
17																														
18																														
19																														
20																														
21																														
22																														
23																														
24																														
25																														
26																														
27																														
28	NUMBERS REPRESENT																													
29	LAUNCH VEHICLE NUMBER																													
30																														
31																														
32																														
33																														
34																														
35																														
36																														
37																														
38																														
39																														
40																														

FY-62

FY-63



Years



TRAINING SCHEDULE	CY-61					CY-62					CY-63					CY-64																			
	J	F	M	A	M	J	J	A	S	O	N	D	J	F	M	A	M	J	J	A	S	O	N	D	J	F	M	A	M	J	J	A	S	O	N
POINTED					↑																														
SYSTEM CONTRACTED											↑																								
DEPT DEVELOPMENT											↑																								
ACTIVITIES REQUIREMENTS											↑																								
COORDINATED																↑																			
VIEW																↑																			
PREPARED																						↑													
TEAM CONFERENCE																																			
PROVISIONING																																			
FINANCING																																			
PROJECT START																																			

FY-62

FY-63

FY-64



WDLAR-S



SECTION IV

DEVELOPMENT - TEST - PRODUCTION

LUNAR EXPEDITION (U)

(LUNEX)

4.1

WDLAR-S-458





RECORD OF CHANGES

CHANGE NO.	DESCRIPTION OF CHANGE	DATE OF CHANGE	REFERENCE TO BASIC PART



[REDACTED]

INDEX

TITLE PAGE	4.1
RECORD OF CHANGES	4.2
INDEX	4.3
4.0 INTRODUCTION	4.5
4.1 DEVELOPMENT OBJECTIVES	4.5
4.1.1 High-Speed Re-Entry	4.5
4.1.2 Manned Lunar Payload	4.6
4.1.3 Cargo Payload	4.7
4.1.4 Abort System	4.7
4.1.5 Space Launching System	4.8
4.2 SUBSYSTEM DEVELOPMENT	4.9
4.2.1 Re-Entry Vehicle	4.9
4.2.1.3.1 Aerodynamics	4.11
4.2.1.3.2 Materials	4.11
4.2.1.3.3 Structures	4.12
4.2.1.3.4 Dynamics	4.13
4.2.2 Propulsion	4.15
4.2.3 Life Support	4.17
4.2.4 Flight Vehicle Power	4.19
4.2.5 Guidance and Control System	4.20
4.2.5.2 Inertial Platform	4.20
4.2.5.3 Star Tracker	4.21
4.2.5.4 Long Baseline Radio Navigation	4.21
4.2.5.5 Doppler Radar	4.22
4.2.5.6 Re-Entry Guidance	4.22
4.2.5.7 Adaptive Autopilot	4.22
4.2.6 Computer	4.24
4.2.7 Communications	4.26
4.2.8 Environmental Data	4.27
4.2.9 Materials	4.32
4.3 TEST PLAN	4.34
4.3.1 Test Categories	4.34
4.3.1.1 Research Tests	4.34
4.3.2 Design Evaluation Tests	4.37
4.3.3 Flight Testing	4.38
4.3.3.1 High-Speed Re-Entry Flight Test	4.39
4.3.3.2 Lunex Re-Entry Vehicle Flight Test	4.39
4.3.3.3 Lunar Launch Stage Flight Test	4.41
4.4 PRODUCTION PLAN	4.44

4.3

[REDACTED]

WDLAR-S-458

This page intentionally left blank

4.4

WDLAR-S-458



4. DEVELOPMENT - TEST - PRODUCTION

4.0 INTRODUCTION

Implementation of the Lunar Expedition will require a completely integrated program involving the development, test, and production of items based on almost every known technical discipline. These technical disciplines are presently being investigated under a multitude of programs and organizations. The Lunar Expedition program will require these technical efforts to be immediately organized and re-oriented where necessary. This can best be accomplished by preparing a detailed development, test, and production program. When this program is completed each technical area can be evaluated by comparing its present program objectives and its required output to meet the Lunar Expedition program requirements. In the following paragraphs the Lunar Expedition development objectives and technical performance requirements are presented. The scope of the major existing technical programs and the necessary re-orientation is discussed.

4.1 DEVELOPMENT OBJECTIVES

4.1.1 HIGH-SPEED RE-ENTRY

At the present time high-speed re-entry data in the velocity spectrum from 25,000 ft/sec. to 45,000 ft/sec. is non-existent. In order to meet the Lunex Re-entry Vehicle development schedule it will be necessary to have high-speed re-entry data during the engineering design program for the manned re-entry vehicle. Thus a compressed and coordinated test program for both ground test facilities and flight testing is necessary.

Immediate action is necessary to schedule and design the high-speed wind-tunnel test program. This will show the type of information that can only be achieved by means of flight testing.

The High-Speed Re-entry flight test program scheduled for the Lunex program is necessary to provide basic data on re-entry as well as to fly specific shapes in the later period of the test program. This selected shape program will be coordinated with the Lunex Re-entry Vehicle design effort.

In order to accomplish the High-Speed Re-entry flight test program it will be necessary to design and develop a test vehicle. This vehicle must use existing boost systems due to time limitations, but the payload will have to be designed especially for this program since none exists at this time. It is believed that the Atlas booster will prove adequate for these tests, but a decision must await the test payload design.

4.5

WDLAR-S-458





4.1.2 MANNED LUNAR PAYLOAD

The largest single development objective for the LUNEX program is to provide a payload capable of transporting men and equipment to the lunar surface and returning them to a selected earth base. This payload would consist of a Lunar Landing Stage, a Lunar Launch Stage and a 3-man Lunex Re-entry Vehicle.

A typical Manned Lunar Payload is shown in a cut-away view in Figure 4-1. The characteristics and General Arrangement of the Manned Lunar Payload are shown in Figures 4-2 and 4-3. This payload is 52 feet 11 inches long, has the c.g. located 33 feet 8 inches from the nose of the re-entry vehicle and the interface diameter with the Space Launching System is 25 feet. The complete payload weighs 134,000 pounds at escape velocity, and a 20,205 pound Manned Re-entry Vehicle is returned to the earth.

The Lunex Re-entry Vehicle must be capable of entering the earth's atmosphere with a velocity of approximately 37,000 ft/sec. At the present time, basic re-entry information for velocities of this magnitude does not exist. Therefore, engineering design effort for this re-entry vehicle must be accomplished concurrently with other major sub-systems developments and integrated with the High-Speed Re-entry test program and the Abort System test and development program. This requires close management control of these programs by the LUNEX Program Office.

Another major problem facing the re-entry vehicle development program is the life support package. The planned schedule will require the manned life support package to be designed on the basis of earlier primate shots, Mercury shots and the Discoverer series. These programs lead toward a manned capability, but this re-entry vehicle requires the first truly space life support package.

The Lunar Landing Stage must be capable of landing the Lunar Launching Stage and the Lunex Re-entry Vehicle on the lunar surface. At the present time this is considered a difficult design problem because little is known about the lunar surface. Actually the best photographic resolution to date is approximately $\frac{1}{2}$ mile. Many theories exist on the formation of the moon and therefore, the characteristics of its present surface. When these two factors are considered the only practical design approach is to provide an alighting system capable of landing on an extremely rough surface. An automatic leveling, orientation and launching system is required for system check-out prior to manned flight. Therefore, any assumption that the Manned Lunar Payload can be moved about on the lunar surface or that the payloads might initially transfer fuel on the lunar surface, might be entirely erroneous and jeopardize the complete Lunar Expedition effort. The landing stage will also have to be developed so that it is capable of landing the Cargo Payloads on the lunar surface.

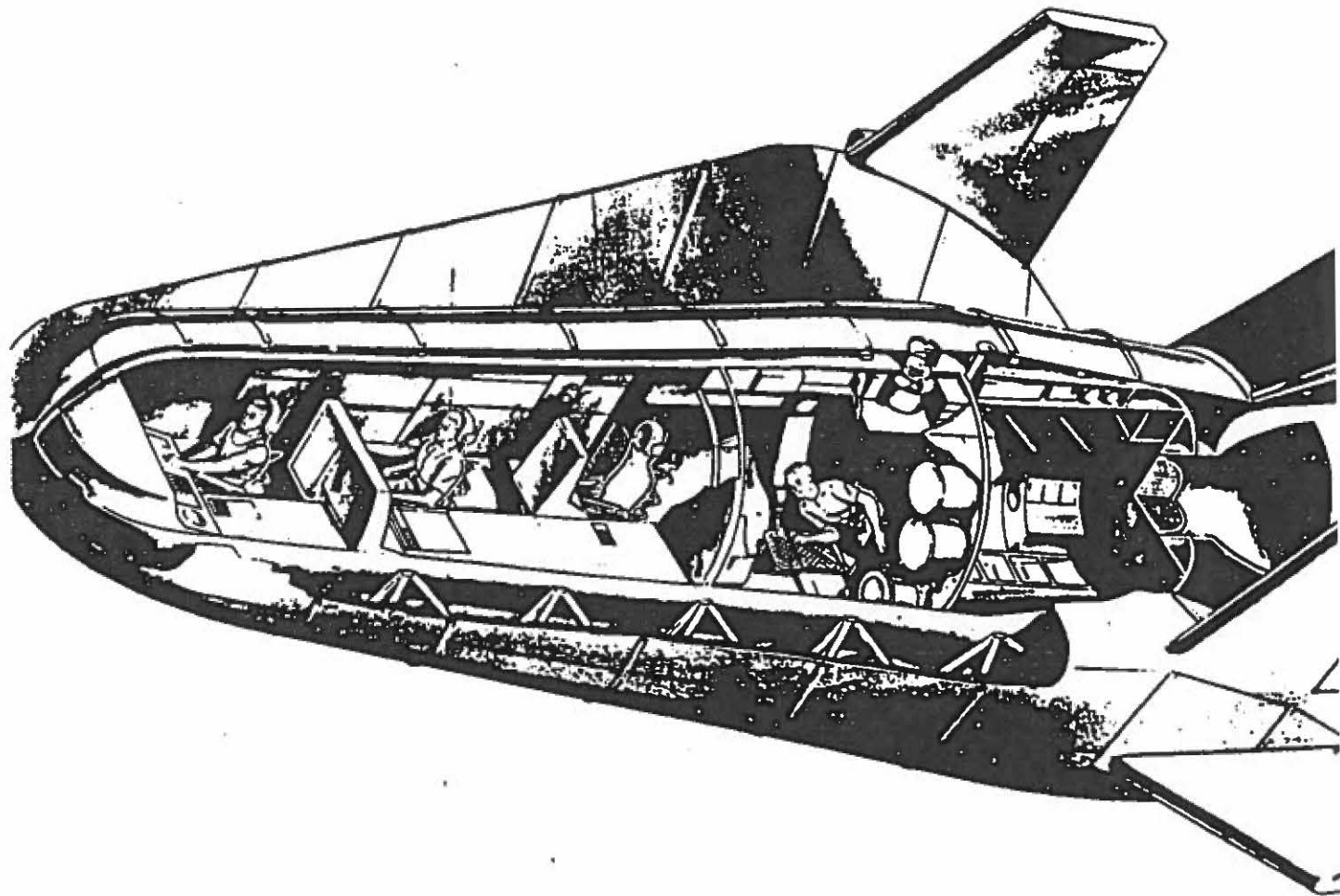


FIGURE 4-1
MANNED LUNAR PAYLOAD

WDLAR.

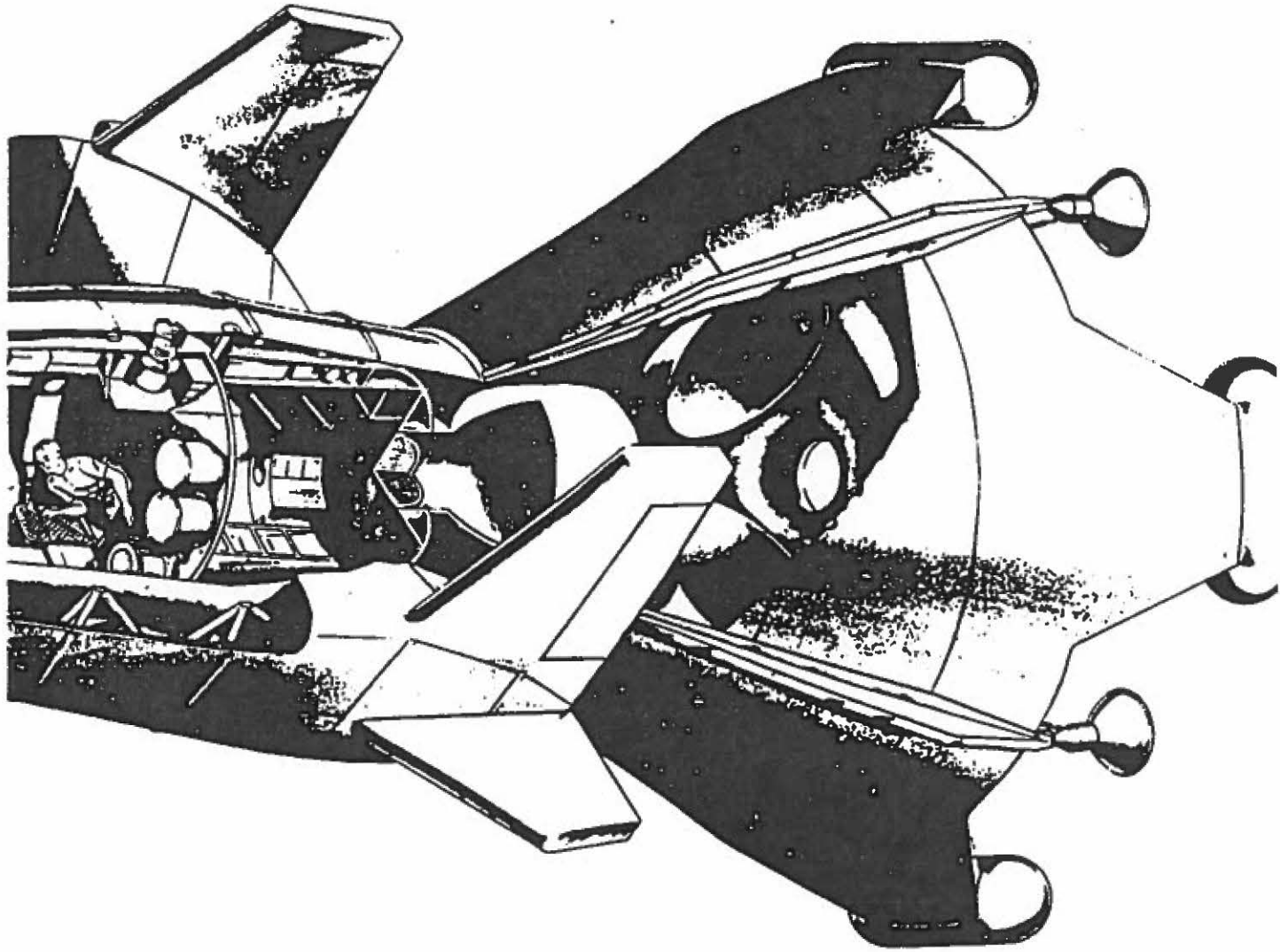
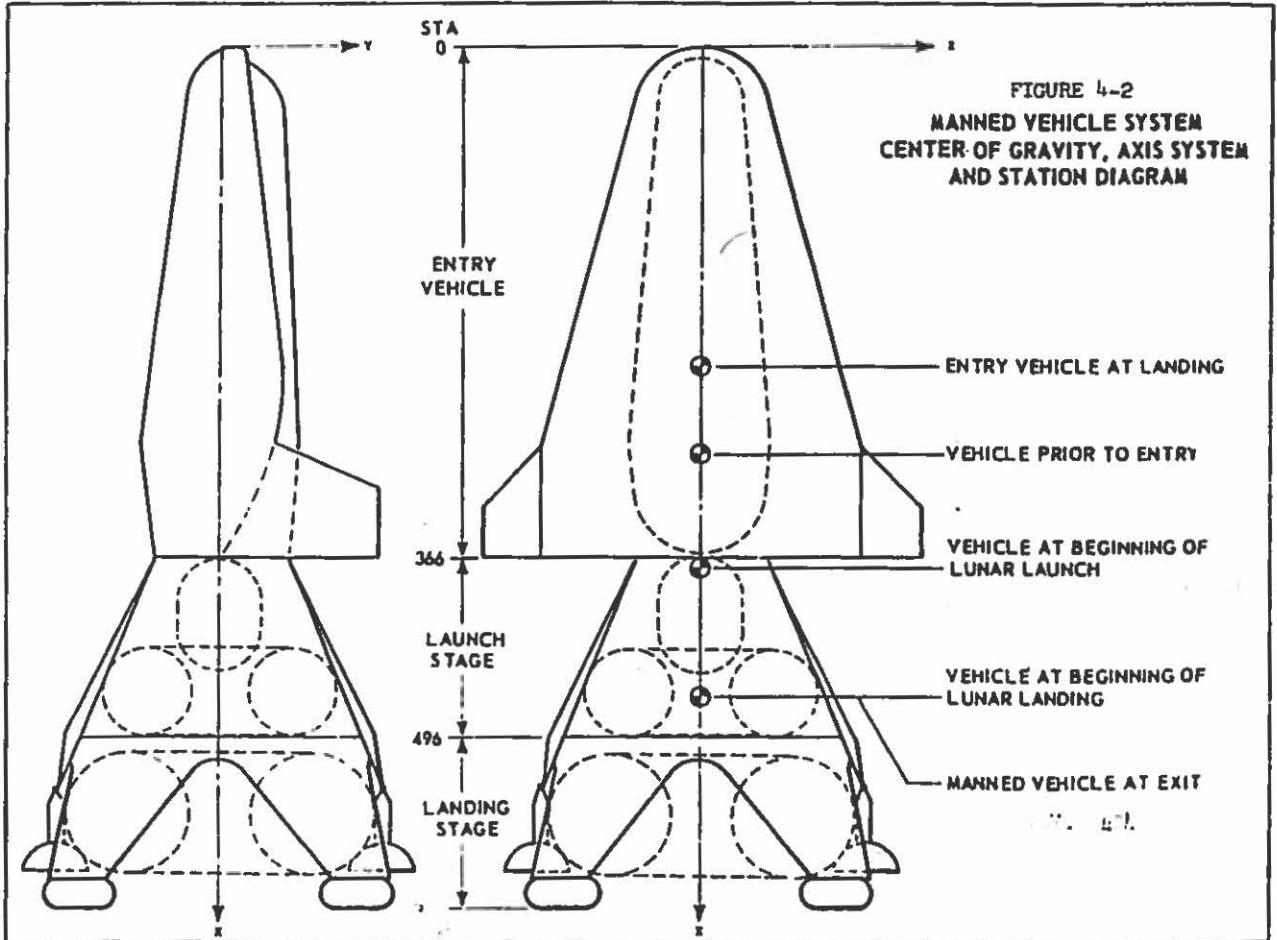


FIGURE 4-1
MANNED LUNAR PAYLOAD

WDLAR-S-458



WDLAR-S-158

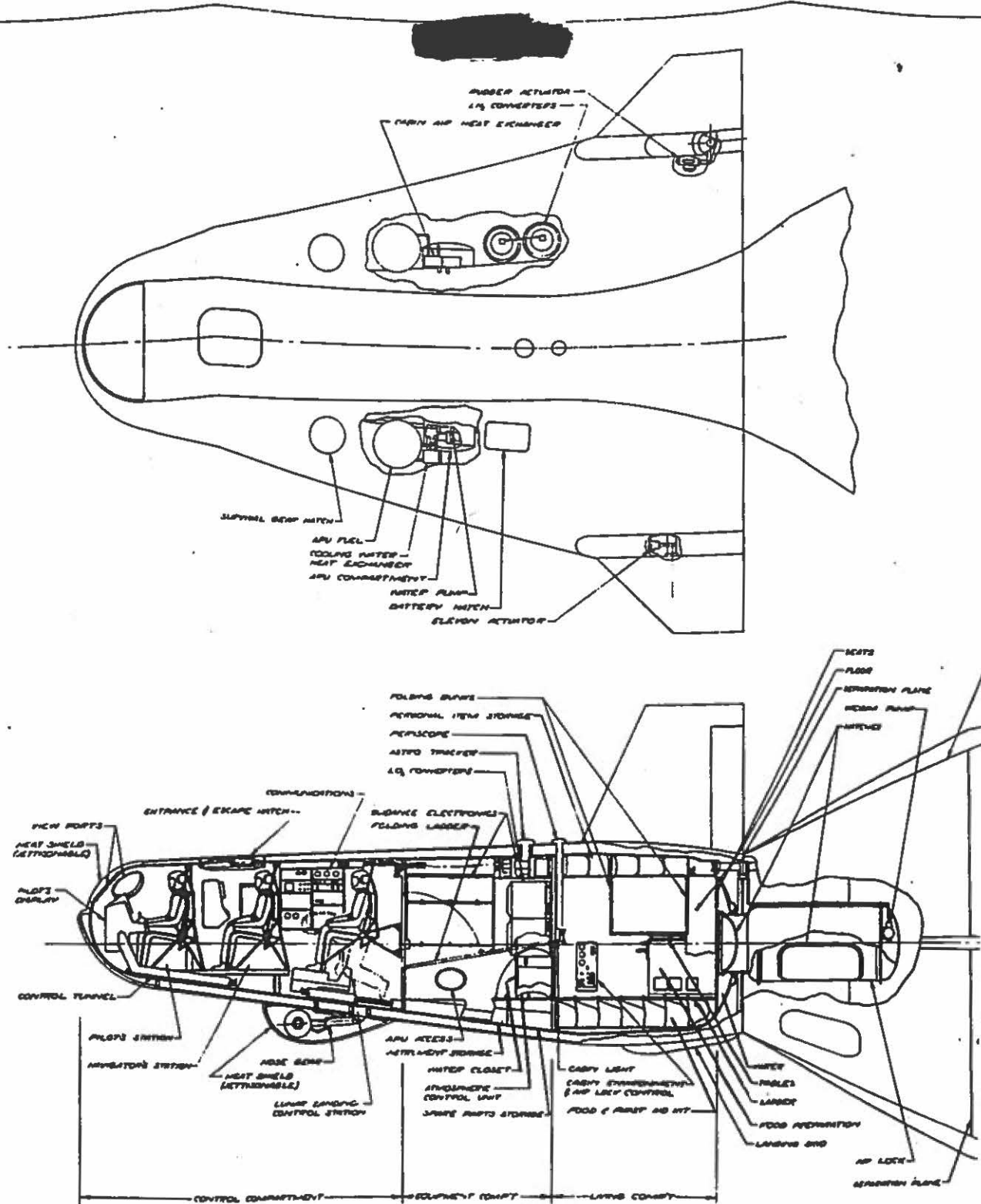


FIGURE 4-3
GENERAL ARRANGEMENT
MANNED LUNAR PAYLOAD

[REDACTED]

The Lunar Launching Stage must be developed with a different philosophy than the previous sub-systems. First, it only operates in a vacuum of space and on the lunar surface. Secondly, it will be required to function after it has been located on the lunar surface for an extended period varying from several days to many months. Therefore, the stage must be developed to launch the re-entry vehicle after being subjected to a better vacuum than available in our best earth laboratory facilities, following possible temperature variations of 400 to 500 degrees, following possible meteorite bombardment and from a less than optimum launch angle. Specifically the stage development must consider propellant boil-off, automatic check-out, self-erection and remote (earth-moon) launching procedures.

The Lunar Launching Stage represents the major reliability problem of the system because an abort capability is planned for every phase of the LUNEX mission except during launch from the lunar surface. During the early lunar flights an abort capability for this phase is just too expensive payload-wise for the Space Launching System. An abort capability during Lunar Launch essentially requires a duplicate lunar launching capability because the man must still be returned to the earth by either this system, or a special rescue flight. Therefore, until lunar support facilities are available a separate system for abort during lunar launch does not seem practical. This creates the requirement to develop an extremely reliable Lunar Launching Stage.

4.1.3 CARGO PAYLOAD

The successful support of the Lunar Expedition will require a capability to deliver relatively large Cargo Packages to the lunar surface. These Cargo Packages will be soft landed at the desired lunar sites by the Lunar Landing Stage. Each Cargo Package will weigh approximately 45,000 pounds and will be specifically designed to carry the items desired to support the expedition. Development of the Cargo Payload and the specific packages will depend upon the Lunar Landing Stage design and the receipt of lunar environmental data. The actual design of the Lunar Expedition Facility will only be possible when detailed information on the lunar surface is available. Then with the facility design information the required materials, equipment, and procedures can be determined and a payload delivery sequence derived. The required payload delivery sequence is essential before the individual payloads can be designed and developed, but timely development of major items of equipment must proceed as their individual requirements become known.

4.1.4 ABORT SYSTEM

The philosophy of abort has been presented in the Program Description section of this document. The development of the abort equipment will require an integrated effort with the re-entry vehicle



design and the test program must be conducted concurrently to provide a reliable and safe system for supporting manned operations.

It is essential that the re-entry vehicle development be conducted so that the life support capsule can also meet the requirements imposed by the abort system. Additional structural and propulsion items must be developed to provide for abort during the earth ascent phase of the lunar mission. The computing and control equipment on the Manned Lunar Payload must be capable of selecting the desired abort mode of operation and initiating the desired actions at any required time throughout the lunar mission.

4.1.5 SPACE LAUNCHING SYSTEM

The Lunar Expedition requires an extensive space launching capability. The development of this capability is a necessary part of the LUNEX Program. At present this development is being included under the Space Launching System program. It is designed to support the low altitude test, orbital, circumlunar, and full lunar flights.

The major problems facing the design and development of the LUNEX Payloads with reference to the Space Launching System, concerns the interface characteristics, trajectory considerations, and earth launch facilities.

The present prime interface characteristics for the Manned and Cargo Lunar Payloads are as follows:

Interface Diameter	300 inches
Escape Payload Weight	134,000 pounds
Payload Length	635 inches
Center of Gravity	404 inches
(Measured from top of payload)	

The Space Launching System is required to provide timely launching capabilities for the Lunar Expedition as follows:

<u>Payload Weight Pounds</u>	<u>Trajectory</u>	<u>Unmanned Flight</u>	<u>Manned Flight</u>
20,000	300 mile orbit	Aug 64	April 65
87,000	300 mile orbit	Dec 65	- -
24,000	Escape Velocity	Dec 65	Aug 66
134,000	Escape Velocity	July 66	Aug 67





4.2 SUBSYSTEM DEVELOPMENT

The development of a manned lunar payload and a cargo package requires the development of subsystems and applied research in many technical areas. Studies have established that the advances in performance in these technical areas can be accomplished to meet the overall program schedules and that no scientific breakthroughs are required. The important point is that items requiring development be identified, that necessary funds be allocated, and that effort be initiated without delay. The following sections discuss major subsystem requirements, present capabilities, and development required. Completed studies conducted by the Air Force and industry have established subsystem requirements in sufficient detail to outline development programs which should be initiated immediately. Present studies will refine these specifications further.

4.2.1 RE-ENTRY VEHICLE

4.2.1.1

The manned re-entry vehicle is a critical item in the development of the manned payload packages. This vehicle must be capable of returning from the moon and re-entering the earth's atmosphere at earth escape velocity (37,000 ft/sec.). It must also have the capability of supporting three men on a 10-day round trip earth-moon mission. This mission would include boost from earth, coasting in earth orbit, ballistic flight to the moon, deboost and landing on the moon's surface, remaining on the moon for one to five days, launch from the moon's surface, re-entering the earth's atmosphere and landing at a pre-selected base on the earth. Structural requirements imposed by inertial and pressure loading during boost, abort, trajectory correction, landing, re-entry, ground handling, and wind loading on the launch pad, have been considered in analyzing desired vehicle characteristics. These studies have also included the heating and its effect on vehicle design as well as the effects of space and lunar environment including particles and radiation, meteorite penetration, and hard vacuum. Present design studies have estimated the total re-entry vehicle weight at 20,205 pounds. The weight breakdown is as follows:

a.	Body		7500
	(1) Structure	3500	
	(2) Heat Shield	4000	
b.	Wing Group		2000
	(1) Structure	800	
	(2) Heat Shield	1200	



c.	Control System		775
	(1) Aerodynamic	600	
	(2) Attitude	175	
d.	Environmental Control		1530
	(1) Equipment Cooling	138	
	(2) Structure Cooling	940	
	(3) Cryogenic Storage	452	
e.	Landing Gear		700
f.	Instruments & Displays		200
g.	Electric Power System		600
h.	Guidance & Navigation		400
i.	Communications		250
j.	Furnishing & Equipment		850
	(1) Seats & Restraints	225	
	(2) Decompression Chamber	175	
	(3) Equipment Compartment	300	
	(4) Miscellaneous	150	
k.	Life Support		400
l.	Crew (3 men)		800
m.	Radiation		1200
n.	Abort System		3000

4.2.1.2

Present re-entry and recovery techniques are outgrowths of the ballistic missile program utilizing ballistic re-entry and parachute recovery. They are not compatible with the velocities associated with re-entry from the moon, with controlled landing, or with manned operation. Present engineering data associated with high speed re-entry is not adequate for vehicle design.

4.2.1.3

A development-test program is required to obtain generalized data on re-entry phenomena and to test scale models

[REDACTED]

of selected vehicle configurations so that final selection and design of an optimum vehicle can be made. Concurrently with this test program the projects within the applied research program will be directed so as to carry out the following investigations to provide necessary data for the Lunex Re-entry Vehicle Design.

4.2.1.3.1 AERODYNAMICS

(1) Study hypersonic-low density aerodynamics including dissociation and ionization, non-equilibrium flow phenomena, and the influence of radiation non-equilibrium on vehicle aerodynamic and heat transfer characteristics.

(2) Initiate an extensive ground based facility program directed at obtaining aerodynamic and heat transfer data up to Mach No. 25 (the maximum useable available capability). These tests would include the G.E. hypersonic shock tunnel in the $M = 18 - 25$ range; Cornell Aeronautical Laboratory hypersonic shock tunnel $M = 12 - 18$; Cornell Aeronautical Laboratory heated hydrogen hypersonic shock tunnel at $M = 20$; AEDC tunnel "B", "C", at $M = 8 - 10$; AEDC E-1 and E-2, $M = 1.5 - 6$; AEDC supersonic and subsonic facilities. This effort will be coordinated with the Lunex Engineering Design program and the High-Speed Re-entry test program.

(3) Correlation of wind tunnel tests in terms of prediction of free-flight vehicle performance characteristics in order to provide correlation between ground tests facilities and free-flight vehicles.

(4) Complete vehicle static and dynamic stability analysis.

(5) Investigate local critical heat transfer problems including those associated with flaps and fins. The use of reaction controls, in order to alleviate critical heating areas, for vehicle stability and control, will be investigated.

4.2.1.3.2 MATERIALS

(1) Materials Development

(a) Low conductivity plastic material development.

(1) Uniformly distributed low conductivity.

[REDACTED]

(2) Tailoring conductivity distribution in material in order to obtain high ablation performance at surface and low thermal conductivity in structure bond line.

(3) Develop materials with low ablative temperatures.

(4) Investigate bonding of materials to hot structure.

(b) Develop minimum shape change materials for aerodynamic control surface and leading edge applications. These materials will include pyrolytic graphite, alloys of pyrolytic graphite, and ceramics.

(2) Materials Analysis

(a) For selected materials above, develop analytical model to predict ablation performance and insulation thickness.

(b) Experimentally study material performance under simulated flight environments with the use of high enthalpy arc facilities ($h/RT_0 = 700$ to 800).

(c) Study the influence of space environment on selected materials. This will include the influence of vacuum, ultraviolet radiation, and high energy particles.

4.2.1.3.3 STRUCTURES

(1) Primary effort will be in the development of load-bearing radiating structures. For this structure, the following areas will be investigated.

(a) Thermal stress analysis and prediction.

(b) Dynamic buckling

(c) Strain gage applications to high temperatures.

(d) Experimental simulation on large scale structures of load temperature distribution, and history. The WADD Structures facility would be the one most appropriate to these tests.

[REDACTED]

4.2 1.3.4 DYNAMICS


(1) Analytical studies in the following areas should be undertaken.

- (a) Unsteady aerodynamic forces at hypersonic speeds.
- (b) Aeroelastic changes in structural loading and aerodynamic stability derivatives.
- (c) Flutter
- (d) Servoelastic coupling with guidance system.
- (e) Fatigue due to random loading.
- (f) Transient dynamic loading.

4.2.1.4

Present projects within the Air Force applied research program will be reviewed and reoriented or effort increased, as appropriate, to provide the necessary data. Projects which can be used for this purpose are listed below:

- 6173 (U) Study of Controlled Final Deceleration Stages for Recoverable Vehicles.
- 1315 (U) Bearings and Mechanical Control Systems for Flight Vehicles.
- 1368 (U) Construction Techniques and Applications of New Materials.
- 1370 (U) Dynamic Problems in Flight Vehicles.
- 1395 (U) Flight Vehicle Design.
- 6146 (U) Flight Vehicle Environmental Control.
- 1309 (U) Flight Vehicle Environmental Investigation.
- 6065 (U) Performance and Designed Deployable Aerodynamic Decelerations



4.2.1.5

In addition to the applied research efforts referred to in Paragraph 4.2.1.4 an intensive study of re-entry vehicle characteristics required for the Lunex mission is being accomplished under project 7990 task 17532. This study will define an optimum vehicle configuration and present the most feasible technical approaches to solving the various re-entry problems. For example, the desirability of ablative and/or radiation techniques for cooling will be determined.



4.2.2 PROPULSION

4.2.2.1

The Manned Lunar Payload requires a booster capable of placing a 134,000 pound package at escape velocity on a selected lunar trajectory. This booster development has been included in the Space Launching System Package Plan and its development will be done for the Lunex program.

4.2.2.2

Propulsion systems for the Manned Lunar Payload which will be developed under this plan are those required for the following operations:

Lunar Landing

Lunar Launch

Trajectory correction

Attitude control

Abort

4.2.2.3

The Lunar Landing Stage must be capable of soft landing at approximately 20 ft/sec. a 50,000 pound payload on the moon. This payload consists of the Lunar Launching Stage and Lunex Re-entry Vehicle. Preliminary design data from studies completed to date show that the manned re-entry vehicle will weigh approximately 20,000 pounds and a launch stage of 30,000 pounds will be required. Similar estimates for the Lunar Landing Stage indicate that it will weigh 85,000 pounds. During lunar landing, if an initial thrust to weight ratio of .45 is assumed as consistent with the deceleration desired and time of deboost, an initial retro thrust of 60,000 pounds is required. At final touchdown on the moon, with all Δv cancelled and assuming essentially all deboost propellant consumed, approximately 10,000 pounds of thrust is required. Some throttling or gimbaling of the engine may be required at the 10,000 pound level to reduce the axial component of thrust. The requirements on the landing engine are for a 60,000 pound engine with a 6 to 1 throttling ratio, or a cluster of four engines of 15,000 pounds thrust and at least one with a throttling range of 1.5 to 1. Assuming a thrust to weight ratio of 1.5 (Moon weight) for the Lunar Launch Stage, a 12,000 pound thrust engine is required for lunar launch. An engine of the

[REDACTED]

IR-115 type will meet these requirements with some development. Minor development will be necessary if the range of throttleability is 20 to 30%. If the range of thrust control is 50% or greater, a more extensive program will be required.

4.2.2.4

In addition to the deboost and launch, it is necessary to provide a trajectory and attitude control propulsion capability. A velocity capability of 300 to 1200 ft/sec. will be required for trajectory corrections during midcourse, lunar landing and return. Attitude control will be required during lunar landing and launch, and midcourse, with specific methods to be determined by optimization studies during vehicle design. There do not appear to be any major development problems to be overcome to provide trajectory correction or attitude control capability

4.2.2.5

An abort system to provide safe removal of the crew in the event of failure before, or during launch must be developed. A propulsion system with an extremely short reaction time is necessary to insure safe crew removal.

4.2.2.6

Specific engine sizing, throttleability requirements, propellant and oxidizer selection, nozzle type, etc., will be determined upon completion of a preliminary design in which such tradeoff comparisons as range of throttling versus use of verniers will be made and optimized selections made. Development work will be initiated within present projects in the Air Force applied research program to raise the level of technology in areas such as throttleability. Projects which can be utilized for this purpose are:

- 3085 (U) Liquid Rocket Engine Technology
- 3148 (U) Development of Liquid and Solid Rocket Propellants
- 6753 (U) Rocket Propulsion Subsystems
- 6950 (U) Propulsion Attitude Testing



4.2.3 LIFE SUPPORT

4.2.3.1


The life support package for the Manned Lunar Payload will be required to function for a minimum of 10 days. This is based on the premise that a one-way trip to the moon will require $2\frac{1}{2}$ days, and the stay on the lunar surface will be on the order of 5 days. The life support system must be capable of supporting three men during high acceleration boost, approximately $2\frac{1}{2}$ days of weightlessness, one to five days of $1/6$ earth weight, $2\frac{1}{2}$ days of weightlessness, re-entry deceleration and return to full earth gravity. At the same time it must provide a shirtsleeve cabin environment under the space and lunar environments, including extreme temperature gradients, absence of oxygen, radiation, etc.

4.2.3.2

Studies of the life support system weight requirements indicate that the life support package can be provided within the weight allocation for the 20,000 pound Lunex Re-entry Vehicle. The life support system weight analysis was based on physiological experiments under simulated space flight conditions such as confinement, special diets, reduced pressure, etc. At the present time approximately 65 to 70 percent of the knowledge required to design the three man package is available. However, to obtain the additional data experimental laboratory and flight testing is required. Most information is presently obtained by piggyback testing aboard experimental vehicles but to support the Lunex program and to meet the desired schedules the BOSS primate program must be initiated and adequately supported.

4.2.3.3

Most of the data available today consists of physiological support (nutrition, breathing oxygen, pressure suits, and restraints for limited periods), but there is a lack of knowledge on prolonged weightlessness and the biological effects of exposure to prolonged space radiations. The BOSS program initially will support a chimpanzee for periods up to 15 days and has been programmed to provide a life support package of sufficient size and sophistication to support a man. Thus, with the BOSS program the data will become available so that the Lunex program can design and construct the life support package as required for April 1965.



4.2.3.4

Throughout this development all life support knowledge and techniques will be fully exploited. Techniques, learned in the work with the Discoverer package were utilized in building the Mercury package. In turn, experience and knowledge gained from Mercury is being fully exploited in the development of the present BOSS package.

4.2.3.5

The life support program (BOSS) is vital to meet the objections of the Lunex program. However, other AFSC programs must be considered for possible application to Lunex and the following are now being evaluated:

6373 (U) Aerospace Life Support

7930 (U) Bio-Astronautics



4.2.4 FLIGHT VEHICLE POWER

4.2.4.1

Electrical power will be required to operate the Lunex Re-entry Vehicle subsystem such as life support, navigation and guidance, instrumentation, and communications. The power requirement for these subsystems has been analyzed and determined to be approximately 3 kw average during a ten-day manned trip to the moon and return. Peak power requirements will be approximately 6 kw.

4.2.4.2

Solar, nuclear, and chemical powered systems were evaluated against these requirements. While all of these systems may be capable of meeting these requirements the chemically powered systems have been selected for early adaptation into the program. Specifically, fuel cells and turbines, or positive displacement engines appear to offer the most advantageous solution. The final selection will be made during the final re-entry vehicle design when a detailed analysis of the trade-offs between various available systems considering relative weight, efficiency, reliability, and growth potential is available. The optimum system may be a combination of fuel cells and chemical dynamic systems with one system specifically designed to supply peak demand. With this approach the system to provide peak load capacity, will also provide backup power in the case of equipment malfunction during a large part of the mission. A battery supply may be used to furnish emergency power required for crew safety during critical periods in the flight.

4.2.4.3

Present level of technology is such that a satisfactory flight vehicle power system will be available when required for the LUNEX mission. Additional development effort should be initiated in certain specific areas, such as a reliability evaluation program for fuel cells and an investigation of the problems of operating chemical dynamic systems in a zero "G" environment.

Close coordination must also be maintained with the manager of project 3145 (U) Energy Conversion, to insure the availability of the required secondary power sources.



4.2.5 GUIDANCE AND CONTROL SYSTEM

4.2.5.1

A study of the guidance and control requirements for the lunar vehicle indicates that the mission can be accomplished by reasonable extensions of present state-of-the-art equipment. The complete lunar vehicle guidance package should be capable of furnishing guidance and control during the following phases of the lunar mission.

Ascent and Injection

Outbound Mid-course

Lunar Landing

Lunar Ascent

Inbound Mid-course

Earth Re-entry

Earth Landing

Present state-of-the-art equipment is capable of handling portions of the guidance and control problem associated with the above phases of flight. However, in order to obtain a complete guidance and control system, it is felt that development of the following items should be undertaken.

4.2.5.2 INERTIAL PLATFORM

Guidance requirements for both the manned and unmanned vehicles can be met with the use of guidance concepts based on the use of inertial and corrected inertial data in a combination of explicit and perturbation computations of present and predicted trajectories. Consequently, an inertial platform configuration suited to the space environment is needed. This platform should be light in weight, highly reliable, and capable of maintaining a space-fixed reference over a long interval of time. Present gyroscopic devices and accelerometers are neither accurate nor reliable enough to accomplish the space mission. An inertial platform which holds great promise for use in lunar missions is one utilizing electrically suspended gyros in conjunction with advanced accelerometers capable of operating in a space environment. Present electrically suspended gyros are capable of operating with a drift rate of .0005 deg/hr/g, and it is anticipated that by 1966, a drift rate of .0001 deg/hr/g

[REDACTED]

will be attainable. Also, no difficulties are foreseen in maintaining suspension of the rotating member in an acceleration field of 15 g's with 30 g's being possible. Development of a small inertial platform utilizing electrically suspended gyros will be required for the lunar mission.

4.2.5.3 STAR TRACKER

In order to increase the reliability and the accuracy of the inertial platform, a compact star tracker for use with the platform during the outbound and inbound mid-course phases of the lunar flight is desired. Also, the star tracker should be capable of operating in a lunar environment so that it can be used for stellar alignment during the lunar launch portion of the mission. The accuracy of present solid state star trackers is approximately 10 seconds of arc and their weight is approximately 15 pounds. However, these trackers are untested in a space environment and must be developed for the lunar mission and for use with the small inertial platform. In particular, the star tracker must be capable of furnishing accurate stellar alignment information to the inertial platform during the lunar ascent portion of the mission. If it is possible to develop a controllable thrust engine in time to meet the launch schedule, the boost and injection guidance problem for the lunar ascent will be simplified as it will be possible to time-control a predetermined velocity path. This development could possibly reduce the accuracy requirement of the star tracker.

4.2.5.4 LONG BASELINE RADIO NAVIGATION

Since manned as well as unmanned flights are planned for the lunar mission, it is necessary to have a navigation system to back-up the inertial system and to increase the over-all accuracy of the guidance and control techniques. Long baseline radio/radar tracking and guidance techniques offer great possibilities for tracking and guiding vehicles in cislunar space. Present studies show that there are a number of problems yet to be solved to give the long baseline radio navigation technique the desired accuracy. Among these problems are 1) the accuracy with which coordinates can be determined for each tracking station, 2) the accuracy with which corrections can be made for tropospheric and ionospheric propagation effects on the system measurements, and 3) the accuracy with which "clocks" can be synchronized at the several stations. Reasonable extensions of the state-of-the-art should be able to overcome these problems however, and it is felt that the development of a long baseline radio navigation system will be necessary for the lunar mission.



4.2.5.5 DOPPLER RADAR

Anticipation that radio beacons will be in place on the lunar surface has somewhat simplified the lunar landing phase of the mission. The use of mid-course guidance will enable the vehicle to approach the moon within line-of-sight of at least one of the radio beacons, and the beacon can be utilized for the approach phase of the lunar landing. However, for final vertical velocity measurement, a sensing technique particularly sensitive to small velocity changes is required. A small CW doppler radar is ideally suited for this requirement. Therefore development of a small, reliable doppler radar which can operate in the lunar environment is needed. In order to decrease the power requirement for the radar it should not be required to operate at a range of over 300 miles.

4.2.5.6 RE-ENTRY GUIDANCE

Major emphasis must be placed on the guidance requirements for the re-entry phase of the lunar mission. Position, velocity, and attitude can be measured by the inertial system, however, other measurements initially required will be temperature, temperature rate, structural loading and air density. Extensive further study is needed to define these measurements with any accuracy. Early earth return equipment should furnish the data necessary to develop the required re-entry guidance package for the lunar mission.


4.2.5.7 ADAPTIVE AUTOPILOT

The control of the re-entry vehicle will require an adaptive autopilot due to the wide variation in surface effectiveness. Adaptive autopilots such as used in the X-15 are available, but extensive development is needed to ready them for use in the lunar mission.

4.2.5.8

The following projects or specific tasks within these projects can be utilized to provide the development required for the LUNEX program.

- 4144 (U) Guidance and Sensing Techniques for Advanced Vehicles
- 40165 (U) Data Conversion Techniques
- 50845 (U) Guidance Utilizing Stable Timing Oscillators

- 
- 50899 (U) Molecular Amplification Techniques
 - 4427 (U) Self-Contained Electromagnetic Techniques
for Space Navigation
 - 4431 (U) Inertial System Components
 - 44169-II (U) Space Adapted Celestial Tracking System
 - 44169-III (U) Multi-Headed Solid State Celestial
Tracker
 - 44169-IV (U) Solid State Celestial Body Sensors
 - 5201 (U) Inertial Systems Technique
 - 5215 (U) Military Lunar Vehicle Guidance
 - 50820 (U) Military Lunar Vehicle Guidance Systems
 - 58821 (U) Military Lunar Vehicle Terminal Guidance



4.2.6 COMPUTER

4.2.6.1

The United States has the ability to provide a suitable computer facility at the present time to support the LUNEX mission. As the milestones in the program are realized and requirements become more complex, the computer capability will improve to meet these more stringent requirements. Detailed studies on the specific needs of the missions, time-phased, will be conducted to determine trade-offs among possible techniques to insure that machine sophistication does not become an end unto itself. The following guidelines providing adequate flexibility, have been followed in arriving at the required development recommendations:

a. Manned vehicles will require extensive data reduction to give an operator real-time display of the conditions around him and solutions to problems such as, velocity and attitude corrections, etc.

b. Sensor control (aiming and sampling rate) and data processing will be accomplished on the vehicle either on ground command, or by operator direction.

c. Mid-course and terminal guidance requirements will make severe demands upon vehicle-borne computational systems.

d. Radiation hazards and effects which are unknown at present could influence the technology that will be utilized for lunar missions.

e. Emergency procedures must be available in the event that the operators become incapacitated and incapable of returning to earth at any time during the mission.

4.2.6.2

The Computer Capability can be expanded in two basic ways by improved hardware, or new concepts. Examples of new approaches which will be reviewed prior to selection of the final vehicle design are the following:

a. Standardized computer functions incorporated into modules so that they can be used to "build" the capability each mission requires. Such a concept would allow a vehicle designer to fabricate a computational facility without resorting to extensive redesign and/or re-packaging. The modularized concept noted above is particularly adapted to unmanned missions.

[REDACTED]

b. For a manned mission two fixed programs could be permanently placed in storage; these would be an overall command, or executive routine to direct the sequences of operation, and the other would be an emergency return-to-base routine that could be actuated by the master control. Thus a 5-pound tape unit would replace a larger core memory and provide a higher degree of flexibility. The principal advantage in this system is that the computer is general-purpose in design and therefore useable on a large variety of missions and unnecessary capabilities will not be carried on a particular mission.

c. An optimized hybrid of analog and digital devices combined to use the better features of each, i.e., speed of problem solution from the analog and precision, flexibility, and data reduction from the digital.

4.2.6.3

Substantial improvements in computer capability, developments, reliability, volume, weight, and power consumption will be available for the LUNEX program by effort expended in the following areas:

a. Core-rope memories to be used in fixed memory applications.

b. Functional molecular blocks. By 1963, the date of earth orbit, it is expected that more than 80% of all computer functions can be performed by this method. Advantages are numerous; high memory densities, extremely small size, small weight and proper consumption.

c. Self-healing, or adaptive programming techniques as a means for back-up on component reliability.

d. Electroluminescent-photoconductive memory devices should be considered for their radiation and magnetic invulnerability. In this regard, pneumatic bi-stable elements should be considered for the same reason.

e. Photochromic storage devices have advantages in high storage densities, 1 billion bits/cubic inch. Certain applications, such as semi-permanent storage could benefit from this feature.

4.2.6.4

The following projects in the Applied Research Area will be utilized to obtain improvements in computer technology:

3176 (U) Space Borne Computation & Control Techniques

4421 (U) Digital Computation Methods & Techniques



4.2.7 COMMUNICATIONS

4.2.7.1

The manned lunar mission will require communications channels between the vehicles and earth and on the lunar surface for telemetry, T.V., voice, and vehicle control. Specific system parameters will depend on the characteristics of the ground tracking network and communications stations which will be used to support the lunar missions.

4.2.7.2

There are no significant technical problems associated with the development of equipment to perform the required communications operations. One exception to this general statement is that during re-entry radio transmission may not be possible at the lower frequencies utilized elsewhere in the mission because of the plasma shield set up by aerodynamic heating. One possible solution may be to provide a separate system operating at 10,000 mcs for re-entry. Overall savings in equipment weight, and power requirements will result from careful analysis and identification of requirements for information transfer and maximum utilization of system components in a dual role. This will be done during the vehicle design phase. While not a requirement for early missions the capability to provide a secure communications link is desirable and will be considered during final design of the communications systems. A secure communications link will be a requirement in later missions. Throughout all phases, communications links critical to mission success should incorporate a high degree of protection against natural or man-made interference, or deliberate jamming.

4.2.7.3

The following Air Force projects will be reviewed and used to provide the necessary results required for the Lunex mission:

- 4335 (U) Applied Communications Research for Air Force Vehicles
- 4519 (U) Surface & Long Range Communications Techniques
- 5570 (U) Communications Security Applied Research

[REDACTED]

4.2.6 ENVIRONMENTAL DATA

4.2.8.1

Present knowledge of the lunar environment is extremely limited and it is necessary to obtain detailed information concerning the lunar composition, subsurface structure, surface characteristics, meteorite flux, level of solar and cosmic radiation, and magnetic field. This knowledge is required to design the equipments for the Lunex program so that personnel may be protected and the mission accomplished.

4.2.8.2

The importance of lunar composition in manned exploration of the moon lies largely in the ability of the moon to provide fuel for vehicles and secondary power, as well as to supplement life support systems with additional water, radiation shielding material, and semi-permanent shelters. Of these lunar resources, water appears to be of major importance both as a fuel and in life support. Water will probably be present both as ice in permanently shadowed zones and as water of hydration in certain minerals such as serpentine.

4.2.8.3

Present knowledge of lunar composition is almost entirely theoretical. The relatively low lunar density (3.34) indicates low metal content. By analogy with the compositions of meteorites it is generally assumed that the moon is composed of chondritic (stony meteorite) material. That this assumption is only partially valid is demonstrated by the fact that chondritic meteorites would have to lose about 10% of their iron content in order to attain this lunar density.

4.2.8.4

The Air Force and NASA are presently trying to determine the lunar composition indirectly through study of tektites, which may be fragments of the moon, and through study of micrometeoritic dust captured above the atmosphere. (Air Force efforts are funded under Project 7698).

4.2.8.5

The Air Force is trying to determine the lunar composition directly by means of spectrometric analysis of the natural X-ray fluorescence of the moon due to the bombardment of the lunar surface by solar radiation. The first knowledge of lunar composition is anticipated in March of 1962. (This work is also funded under Project 7698).

[REDACTED]

4.2.8.6

NASA intends to measure the lunar composition directly by means of its Surveyor lunar probe now scheduled for mid 1963.

4.2.8.7

Neither Air Force measurements of overall lunar composition, nor NASA measurements of spot compositions will satisfy the requirement for location of lunar resources. The NASA Prospector vehicle scheduled for 1966 will obtain more widespread data, but what is urgently needed is detailed knowledge of the variation of lunar composition over the whole surface. This can only be accomplished by a lunar orbiting vehicle with appropriate instrumentation. NASA presently has this planned for 1965 and the appropriateness of their instrumentation remains in doubt. Also this is too late to meet the requirements of the LUNEX program.

4.2.8.8

The importance of lunar subsurface structure in exploration of the moon lies largely in a possible collapse hazard under vehicles and personnel, and in the possibility of utilizing subsurface structures as shelters and storage facilities.

Present knowledge of lunar subsurface structure is based on a theoretical extrapolation from the presumed origin of the surface features. The majority of lunar geologists believe that lunar craters were formed by means of the impact of large meteorites, and that only limited volcanism has occurred in the lunar highlands. The maria, on the other hand, are thought to be giant lava pools; although the melting is assumed to have been triggered by asteroidal impact.

Based on these theories of origin for the lunar surface features, it is thought that the subsurface structure of the lunar highlands will consist largely of overlapping layers of debris ejected from the impact craters. The collapse hazard of such material is negligible. The maria should be covered by no more than 40 feet of vesicular (bubble filled) lava, with maximum vesicle (bubble) size about six feet in diameter. Such terrain could present a collapse hazard, the severity of which will depend upon actual (rather than maximum) vesicle size.

It should be noted, however, that a rival theory for the origin of lunar craters holds that they were produced by volcanism as calderas. Should this theory be correct, the collapse hazard in the highlands would probably exceed that on the maria.

[REDACTED]

In order to determine the lunar subsurface structure, it is necessary to place instruments on the moon. Thus, the Air Force, although contributing theoretical evaluations as described above (under Project 7698), has no program for directly determining lunar subsurface structure. NASA plans to place seismometers and a coring instrument in the Surveyor vehicle in mid-1963 to determine these parameters. Again, point measurements are not sufficient, and geophysical instrumentation adequate for determining subsurface structure from the lunar orbiting vehicle (1965) should be developed.

4.2.8.9

The importance of lunar surface characteristics lies in their critical importance in design of both rocket and surface vehicles and in lunar navigation. Critical surface characteristics include gross topography, microtopography and the nature of the lunar dust. Of these characteristics, knowledge of gross topography will be important in overall rocket design and in design and operation of rocket landing and navigational equipment. The microtopography (relief less than 20 feet) will be important in the design of rocket landing equipment and the vehicle for surface exploration. The nature of the surface dust will be most important in design of the vehicle for surface exploration.

Present knowledge of gross topography shows that slopes are generally gentle, and topographic profile have been determined over a limited amount of terrain. Present knowledge of microtopography is very limited. Radar returns, once thought reliable indicators of low microrelief, are now considered by most space scientists to be so poorly understood that conclusions may not be drawn from them. Photometric data appears to indicate a rather rough surface, but this data is also subject to more than one interpretation. Present knowledge of the nature of the lunar dust is entirely theoretical. The leading school of thought holds that the dust is compacted and sintered. An opposing school holds that the dust bears an electrostatic charge. Should the dust bear an electrostatic charge, it would be very loose and probably subject to migration. The hazard to surface vehicles and even personnel is apparent.

Gross lunar topography on the visible face is presently being mapped by the Aeronautical Chart and Information Center based on techniques developed under Project 8602. Maximum resolution is about 1/3 mile, and average resolution is about one mile. Higher resolution photography and photography of the back side of the moon will be obtained by the lunar orbiting vehicle planned by NASA for 1965. A cooperative effort by ACIC and NASA is presently envisioned to produce the necessary topographic lunar charts.

4.29

[REDACTED]

WDLAR-S-458

[REDACTED]

Microtopography is being studied by the Army Corps of Engineers through radar experiments. (The Air Force work is being done on the Millstone radar equipment) The nature of the lunar dust is being studied primarily by the Air Force under Projects 7698 and 8602 by means of radiometric studies from high altitude unmanned balloons and results are anticipated early 1962. NASA anticipates obtaining at least partial data on the nature of the dust from Surveyor (mid 1963) by television observation of the lunar surface and by the landing characteristics of the vehicle.

4.2.8.10

The meteorite flux and level of solar and cosmic radiation near the lunar surface are important for the survival of personnel either on the lunar surface or in vehicles and shelters.

Present knowledge of these parameters is fairly precise as a result of satellite and deep space probe experiments by NASA and the Air Force. Only the radiation environment within the first few meters of the lunar surface is still speculative as a result of uncertainties in our knowledge of the interaction of solar and cosmic radiation with the lunar surface materials. It seems likely that a cloud of ions will be produced by radiation bombardment as well as secondary X-rays. The density of the electron cloud is unknown, and may be critical for lunar communications.

The Air Force is studying the lunar and cislunar radiation environment under Projects 6687, 6688, 7601, 7649, and 7663 by means of satellites, deep space probes, and vertical sounding rockets. The NASA Surveyor vehicle (mid-1963) should give detailed knowledge of the radiation environment at the lunar surface.

4.2.8.11

The lunar magnetic field may be important to space and lunar surface navigation, and in its effects on ionized lunar materials.

The Russian Lunik II indicated that the lunar magnetic field must be very small. The Russians were not clear on how small, but it is generally thought that the moon does not possess a magnetic field. Thus, all magnetic effects should be derived from the very low intensity interplanetary field and magnetic fields, "frozen" into solar plasmas.

SECRET

The Air Force is studying the interplanetary magnetic field under Project 7601. NASA should be able to determine the field near the lunar surface by means of the Ranger vehicle during 1962, and the field at the surface by means of Surveyor (mid-1963).

4.2.8.12

Two facts are apparent from a study of the data outlined above. First, one Air Force project (7698), which was funded for only 250K in 1962 and 300K in 1963 is responsible for most of the research on the lunar environment. More funds are required for a speed-up in this program. Second, many critical experiments are tied to the NASA lunar orbiting vehicle, which has not been considered a very important vehicle by NASA. This program is essential to the LUNEX and should be speeded up and planned more carefully.

4.2.8.13

Effort on Air Force Project 7698 will be increased substantially to insure that data necessary for the LUNEX mission is available. A close working relationship will be established with NASA to provide, if possible, the inclusion of Air Force requirements in their planning for lunar programs both as regards to objectives and scheduling.

[REDACTED]

4.2.9 MATERIALS

4.2.9.1 The Lunar expedition imposes rigid requirements on materials to maintain their characteristics while subject to radiation, vacuum, temperature extremes, and meteorites. This problem must be considered by the individual subsystem design. It is intended to point out here the overall material problem and programs which will contribute to its solution.

4.2.9.2 The absence of an atmosphere on the moon increases the radiative flux (particle and electromagnetic) from the sun and as such potentially increases the possibility of damage to man and light-weight plastic structures through the formation of free radicals and subsequent depolymerization. The need for light-weight shielding is apparent. The vacuum conditions of the moon would aggravate the problems associated with moderately volatile constituents of plastics, lubricants, etc. For instance, the relatively volatile plasticizers in a plastic material could evaporate and interfere with the plastic function. Finally, the results of impact of micrometeorites on structural materials must be determined. All desirable properties must be acquired without penalty of weight. In addition to the problems encountered on the Moon, similar problems are encountered while in transit. In particular the heating encountered on re-entry into the earth's atmosphere at 37,000 feet per second presents a severe material problem.

4.2.9.3 Some of the specific material requirements that can be identified are:

- a. Lubricants that will function for long periods of time in a vacuum and temperature conditions such as exist in the moon.
- b. Materials that will not sublime in a vacuum at moon temperature.
- c. Light-weight shielding material against meteorites.
- d. Light-weight radiation shielding.
- e. Shock-absorbing material that will function at 330°F.

[REDACTED]

f. Coatings that will resist radiation, especially during periods of solar flares.

g. Glues and adhesives that will function with lunar materials.

4.2.9.4 Present projects to raise the level of technology in materials are listed below. They will be supported as required to insure success of the Lunar mission.

7312 (U) Finishes and Materials Preservation.

7320 (U) Air Force Textile Materials.

7340 (U) Non-Metallic & Composite Materials.

7351 (U) Metallic Materials.

7371 (U) Applied Research in Electrical, Electronic, and Magnetic Material.

7391 (U) Energy Transmission Fluids.

4.2.9.5 While work in the basic research program cannot be counted on to provide technical break through within the time schedule of the LUNEX program, materials study of this type will be monitored so that all technical advances can be integrated into the LUNEX program. Specific examples of projects of this type are:

8806 (U) Research on Materials at High Temperature.

7022 (U) Surface and Interface Phenomena of Matter.

9760 (U) Research in Properties of Matter.



4.3 TEST PLAN

The development and production of the equipments for the Lunar Expedition will require a concurrent and detailed test program.

The test program will be carried out on the basis of research tests to establish design criteria, materials, tests, component tests and finally, a progressive series of tests as components are assembled into subsystems and major systems and structures. Integration tests for flight suitability will be conducted for all functioning systems and the complete vehicle. Payload effects on the booster structure will be determined with a simulated payload. Subsequently, a flight-type payload will be used to demonstrate booster-payload system compatibility, reliability, crew safety, and mission performance.

Emphasis will be placed early in the program on research tests to derive basic design criteria, define the configuration and determine aerodynamic parameters.

Tests are to be run at progressively higher levels as the design evolves. Thus, entire subsystems, combined subsystems and complex major structures are to be subjected to evaluation tests as necessary to investigate component and subsystem interactions, or to prove out complex structural designs.

A captive-test-vehicle firing program will be the culmination of ground development testing. The over-all objective of the captive-firing program is to demonstrate satisfactory integration of the propulsion system with other vehicle systems that have an interface, direct or indirect, with the propulsion system. The early tests will be conducted in a simulated vehicle with the airborne vehicle systems installed on a heavy-wall propellant tank section. The tanks will be supported by a test stand structure which will also restrain the tanks against propulsion system thrust forces. For final testing a flight-type configuration will be used during captive tests.

Flight testing of the High-Speed Re-entry Test Vehicle, the Abort System and Orbital, Circumlunar and unmanned Lunar Landing and Return Vehicles will complete the development program.

4.3.1 TEST CATEGORIES


4.3.1.1 RESEARCH TESTS

Tests will be run in appropriate research laboratories to define basic design criteria in at least the following technical areas:

4.34



WDLAR-S-458

- 
- a. Propulsion
 - b. Heat transfer
 - c. Aerodynamic forces and pressures
 - d. Materials
 - e. Statics (structures)

4.3.1.1.1 Propulsion Tests--Wind and vacuum tunnel tests will be conducted to investigate the problems of multiple re-start in a vacuum environment, to develop throttleable techniques, to determine lunar landing problems, and to determine the desirability of using the same engines for lunar landing and lunar launching.

Tests will be made to evaluate the propulsion stage for the circumlunar flights and to determine the capability of the abort propulsion system to accomplish its objective.

4.3.1.1.2 Heat Transfer Tests--Testing will be required on the insulation for the liquid hydrogen tanks to determine:

- a. Optimum material thicknesses and weight
- b. The amount of liquid hydrogen boiloff
- c. The air leakage through seals
- d. The airload effect on structural integrity
- e. The thermal bowing of insulation panels
- f. The separation distance between panel and tank skin

Scale-model or modified full-scale air-conditioning tests will be conducted on engine compartments, adapter sections and flight equipment storage areas.

Heat transfer characteristics for selected materials, structures, and surfaces will be required to support the engineering design.

4.3.1.1.3 Aerodynamic Force and Pressure Wind-Tunnel Tests--Wind-tunnel model tests of the launch vehicle and payload configuration will be required to accurately determine the aerodynamic forces and moments imposed on the vehicle during the boost trajectory.

[REDACTED]

These tests will provide data for determination of structural design criteria, aerodynamic stability and control parameters, and the performance penalty incurred by aerodynamic drag. The test program will include both force and pressure measurements through the flight Mach number range for which these effects are significant.

Wind tunnel testing of selected shapes at velocities never before studied will be necessary to determine re-entry vehicle characteristics. Particular emphasis will be placed on control surface capability and heating problems. Maneuverability limits, g loadings, re-entry corridor characteristics and subsonic landing characteristics must be determined in support of the engineering design program.

Integration and correlation of the ground wind-tunnel testing with the high-speed re-entry flight test program is essential.

4.3.1.1.4 Material Tests--A materials development test program will be undertaken to determine the allowable design strength values and provide design information on the selected structural materials over the appropriate temperature ranges for the base metals, ablative surfaces, and welded joints. Particular emphasis will be placed on tendency toward brittle fracture under service conditions and in selecting materials for re-entry at 37,000 ft/sec. The testing program will consist of at least the following:

- a. Smooth and notched static tensile tests of the selected materials.
- b. Static tensile tests of welded joints, both fusion- and resistance-welded, for the selected joint configuration for each type of sheet material.
- c. Smooth and notched static tensile tests of the selected extrusion and forging materials.
- d. Notched impact tests of the extrusion and forging materials.
- e. Low-cycle, high stress fatigue tests of welded joints made by the fusion and resistance methods for the selected joint configurations in sheet materials.

This data will be accumulated for the appropriate temperature ranges, i.e., from elevated re-entry temperatures to the cryogenic temperatures in the tanks, as dictated by the projected environmental requirements. In addition, supporting tests such as metallographic examinations and chemical composition determinations will be made as required.

[REDACTED]

4.3.1.1.5 Static Tests--The static-test program will include design and structural substantiation testing to demonstrate structural integrity of the Manned Lunar and Cargo Payloads.

Structural substantiation testing to design loads and temperatures will be accomplished on a full-size stub tank, identical (except for length) to the Lunar Landing Stage tank. This will ensure that load introduction and takeout will be representative of the flight article.

One complete interstage adapter will be tested to ultimate design loads under appropriate environmental conditions. The adapter will be attached to a stub tank identical to the Lunar Launching Stage tank section in every respect except length, to ensure realistic load introduction and takeout.

A stub tank will also be used to demonstrate the integrity of the Lunar Launch Stage tank construction under design loads and environments. Methods of introducing the payload vehicle loads into the adapter section and thus the Lunar Launch Stage tanks will be determined.

Tests will also be run on full-size tank bulkheads. These will be attached to a segment of typical tank structure, adequate to allow the bulkhead behavior to be representative of that of the flight article under design conditions. These bulkheads will be tested to ultimate design loads to ensure their structural reliability at all points within the flight regime.

Ground handling equipment tests will cover critical fittings and joints for structural substantiation of these items under design conditions.

4.3.2 DESIGN EVALUATION TESTS

Component design evaluation testing is defined here as informal testing conducted by the vehicle contractor, or vendor test labs, for the purpose of basic design evaluation prior to production release, and to pinpoint critical areas in prototype packages.

Qualification testing is defined as those formal tests performed on flight-type hardware to demonstrate compliance with design specifications. A qualification test plan will be prepared approximately 90 days after engineering go-ahead outlining the qualification test conditions. The qualification tests are to be performed in strict accordance with written and approved detailed test procedures, and witnessed by the Air Force, or an approved representative.

[REDACTED]

The vehicle contractors test laboratories will conduct these tests, or subcontract and supervise them at an independent testing agency. Components to be tested will be determined during the engineering design effort.

Controlled environmental conditions will simulate conditions that airborne and ground support equipment are expected to experience during manufacturing, shipping, storage, preflight and flight.

Environmental testing conditions will be established based on data already obtained in research and development programs on large rocket-powered vehicles and associated support equipment. Conditions for shipping, storage and handling environmental tests are established in current military and commercial specifications. Subsystem, combined subsystems, and structural evaluation tests will be run in appropriate laboratory facilities to investigate component and subsystem interactions, and to prove out structural designs. Acceptance test procedures will also be developed for use in the factory on deliverable hardware.

A test plan describing the basic conditions and test objectives of each factory system test, along with the checkout parameters and recorded evaluation data, will be prepared.

A final acceptance test will be required at the time the contractor delivers the vehicle to the Air Force. Test conditions will be as close to the flight conditions as is feasible and safe. All systems will be energized and operated simultaneously.

A final acceptance test evaluation document will be prepared for use by the Air Force and the contractor in determining compliance with test requirements.

Systems acceptance test procedures will be based on all critical parameters required to determine proper functioning of each system in accordance with design specifications and drawings. This will assure a coordinated effort of vehicle design, test equipment design and factory acceptance testing.

4.3.3 FLIGHT TESTING

The LUNEX flight test program represents a long and expensive effort leading to the first manned landing on the moon. It requires basic research flights, equipment checkout flights, capability demonstration flights and finally the manned and cargo Lunar Expedition flights. This type of effort can only be achieved efficiently and at a minimum cost if the end objective is always clear and the program is designed to meet this objective.

[REDACTED]

The Lunar Expedition flight test program will provide many side, but important space capabilities. For example: in April 1965 the first orbital flight capability in a true space vehicle will be possible; in September 1966, man will make his first flight around the moon in a fully maneuverable and recoverable re-entry vehicle; and in August 1967 the first man will land on the moon. Essentially these can all be called test flights, but in each case the system is only at the beginning of its capability instead of being a dead-end item. Each of these capabilities may readily be expanded to provide a military capability if necessary.

The flight test program is summarized on the Lunar Expedition Test Schedule. The following major objectives will be accomplished in the indicated part of the test program.

4.3.3.1 HIGH-SPEED RE-ENTRY FLIGHT TEST

Since present wind-tunnel capabilities are limited to approximately 18,000 ft/sec., it is necessary to perform re-entry flight testing at velocities that range from 25,000 to 45,000 ft/sec. The major objectives of this test program are to:

a. Verify or disprove present theories on basic re-entry techniques as extrapolated to the stated velocity range.

b. Determine problem areas and develop new fundamental theory, numerical procedures and testing techniques where required for this re-entry range.

c. Identify the following:

(1) Items that can be investigated further on a laboratory scale.

(2) Specific laboratory facility requirements.

(3) Additional flight tests that must be performed.

d. Support the engineering design program for the LUNEX by providing the above data and special shape testing if required.

4.3.3.2 LUNEX RE-ENTRY VEHICLE FLIGHT TEST

The Lunex Re-entry Vehicle will be flight tested by various techniques and in varying environments. Each test will be designed to allow the vehicle to proceed to the next more

[REDACTED]

difficult step. The major testing steps are presented below with the major test objectives for each step.

a. Prototype Drop Test

Prototype vehicles will be drop tested from a B-52, or equivalent, in both an unmanned and a manned series of tests. Each series will be designed to:

- (1) Establish landing characteristics.
- (2) Measure inherent subsonic, transonic, and hypersonic stability and control characteristics of the vehicle.
- (3) Explore the flight characteristics of the re-entry vehicle in every possible portion of the Mach number spectrum.
- (4) Train LUNEX Crews.

b. Orbital Test:

Maximum use will be made of SAINT orbital test information and unmanned and manned flights will be accomplished. These tests will demonstrate:

- (1) The capability of the Lunex Re-entry Vehicle to operate in the orbital area.
- (2) Re-entry capability at velocities of 25,000 ft/sec.
- (3) The maneuverability of the re-entry vehicle and its capability to land at a preselected earth base.

c. Circumlunar Test

This flight will use the Circumlunar Propulsion Stage and the Lunex Re-entry Vehicle. The major test objectives are:

- (1) To send an unmanned and then a manned vehicle around the moon and return for an earth landing at a selected base.
- (2) To check out guidance, flight control, communications and life support sub-systems in a true space environment prior to landing on the lunar surface.
- (3) To perform manned reconnaissance of the lunar surface.

[REDACTED]

d. Lunar Landing and Return

The unmanned vehicle flights will check out the Manned Re-entry Vehicle and related systems to provide a completely automatic system before man first tries the most difficult step in the LUNEX program. The major test objectives for these flights will be to:

- (1) Check out the Lunar Landing and Lunar Launching Stages.
- (2) Check out the Cargo Payload's ability to deliver cargo packages to a preselected site on the lunar surface.
- (3) Place three men on the lunar surface so that the initial surface reconnaissance can be accomplished prior to the arrival of the Lunar Expedition.

4.3.3.3 LUNAR LAUNCH STAGE FLIGHT TEST

The Lunar Launch Stage will be initially checked under orbital conditions to:

- a. Demonstrate space environment operation.
- b. Demonstrate engine restart after "soaking" in space for an extended period.
- c. Demonstrate automatic checkout, communications, and remote control capability.

The Lunar Launch Stage will then be flight tested with the complete Manned Lunar Payload for the unmanned and manned Lunar Landing and Return Missions.

4.3.3.4 LUNAR LANDING STAGE FLIGHT TEST

The Lunar Landing Stage will be initially checked out by drop testing. These tests will:

- a. Demonstrate landing techniques and the capability of the selected landing system.
- b. Evaluate the effects of unexpected terrain variation.
- c. Determine the effects of malfunctioning equipment during the landing maneuver.

[REDACTED]

d. Evaluate the effects of engine blast on landing surfaces similar to the predicted lunar surface.

The Lunar Landing Stage will receive its first space evaluation in orbit. The major objectives are:

- a. Correlate drop-test data with orbital or space operations.
- b. To determine the effects of space environment on the stage.

The first Lunar Landing with the Lunar Landing Stage will be accomplished with a cargo package as the payload. When this has been completed a Lunex Re-entry Vehicle will be landed unmanned. The test objectives are to:

- a. Demonstrate the feasibility of landing large cargo packages on the lunar surface.
- b. Demonstrate the feasibility of automatically landing a "manned vehicle" while unmanned.
- c. Provide a man-rated system for the Lunar Expedition.

4.3.3.5 CARGO PACKAGE CONFIGURATION FLIGHT TEST

Various configurations for the Cargo Package of the Lunex Cargo Payload will be tested. The objectives are to:

- a. Determine the Cargo Payload aerodynamic characteristics.
- b. Demonstrate that the Cargo Packages can be delivered where desired on the Lunar surface.

4.3.3.6 ABORT SYSTEM FLIGHT TEST

The fact that a system of this magnitude must possess some measure of "unreliability" is recognized and a "fail safe" abort system is required to insure the survivability of the crew. The test objectives for the Abort System Flight Test Program are to:

- a. Demonstrate that crew members in the manned Lunex Re-entry Vehicle can be recovered safely in the event of a malfunction.
- b. Demonstrate that the Space Launch System is capable of shut-down, or thrust vector change, so that crew abort is possible.



4.3.4 CHECKOUT AND TEST EQUIPMENT

The test equipment will be fully automatic with quantitative readout capability for all critical functions. The Lunex checkout equipment will be the same, or compatible with the Space Launching System checkout equipment. The equipment will be capable of checking out the complete booster and payload system as well as any individual, or isolated component, or subsystem. It shall be fully capable of checkout of any one stage, or the re-entry vehicle, as an isolated unit, and will mate with the stage interface functions and furnish appropriate operational or simulated error inputs to the stage systems.

For the time period of interest, it is entirely practical to incorporate malfunction prediction capability for preventative maintenance. This will entail a computer function which will accurately control and record the input and output signal values to each system or component. Variations in operation will be recorded and compared to predetermined failure values, or characteristics and will forecast the remaining service life of the system under test.

The checkout equipment shall be installed in each blockhouse and it may be used in conjunction with the launch area. This same equipment shall be utilized in the vehicle manufacturing checkout and test functions, as well as in the launch complex, receiving, inspection, and maintenance facilities.

The blockhouse equipment will monitor the launch control system commands and inputs as well as those of the payload. Because the launch control equipment will display only go/no-go signals, the checkout and test system will furnish quantitative displays of any function under question for human appraisal and decision.

When the systems are flown unmanned and on the early manned lunar flights it will be necessary to provide automatic checkout where appropriate via a telemetry link. As an example, prior and during lunar launch the checkout procedures will be monitored at the earth control station via the telemetry link.



4.4 PRODUCTION PLAN

At the present time a detailed Production Plan is not available. However, the present preliminary design study will be completed on 30 June 1961 and the final report to be provided by six independent contractors will include their proposed Production Plan. When the study results have been evaluated a Production Plan for the Lunar Expedition will be prepared.

Several points are apparent at this time and they are presented for completeness in this plan.

4.4.1 QUANTITY

Limited quantities of early equipments will be required until the test program improves and increases the capability of each item and production quantities become possible. Thus, as development and testing proceeds the equipments will become more standardized and production techniques will become more applicable. When the Lunar Landing and Return flights are initiated it will be necessary to launch vehicles at rates that vary from one to two flights per month. When the Lunar Expedition is actually underway the launch rate will remain at a rate of two per month for an extended period. Considering the size, weight, complexity and importance of these vehicles this represents production rates even when compared to past aircraft or missile production programs.

4.4.2 QUALITY

The inherent reliability of the systems required for the Lunar Expedition program will be maximized by good design practice. Reliability testing represents a major effort of the test program, but the achieved reliability of these systems can only be maintained during production by an excellent quality control program. This means that good organization, adequate manning and early recognition of the quality control problem is essential. Close coordination is required between the quality control personnel and the reliability personnel in the design, development, and test program if the reliability program and the test results are to provide the proper guidance so that quality can be maintained throughout the production effort.

[REDACTED]

4.4.3 LOCATION

It is anticipated that most of the major systems and sub-systems can be manufactured at facilities, or locations presently in existence and available to the aerospace industry. However, the possibility does exist that certain items, such as the first stage solid propellant stage, may be manufactured at the Lunar Launch Complex due to its size and transportation limitations. These particular items have not been specified at this time, but this will be done as soon as possible.

4.45

WDLAR-S-458



SECTION V

BUDGET AND FINANCIAL

LUNAR EXPEDITION (U)

(UNCLASSIFIED)

5.1

REF ID: A668458





RECORD OF CHANGES

CHANGE NO.	DESCRIPTION OF CHANGE	DATE OF CHANGE	REFERENCE TO BASIC PART

WDLAR-S-450

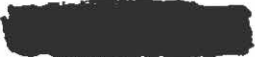
5.2





INDEX

TITLE PAGE	5.1
RECORD OF CHANGES	5.2
INDEX	5.3
5.0 INTRODUCTION	5.5
5.1 BUDGET ESTIMATE AND FINANCIAL PLAN.	5.5
5.2 COST ESTIMATES.	5.6
5.3 FY 62, 63 FINANCIAL PLAN	5.7





This page intentionally left blank





5. BUDGET AND FINANCIAL

5.0 INTRODUCTION

The funding estimates for the Lunar Expedition Program are based on results obtained from previous concept, feasibility, and preliminary design studies. These results were published in the Lunar Observatory Final Report, Volume I - Study Summary and Program Plan, numbered AFBMD TR 60-44 and dated April 1960. The costing of this program was accomplished by the Rand Corporation and was based on a completely integrated program.

The funding estimates for the Lunar Expedition represent all the costs of establishing a habitable facility on the moon except the cost of developing the Space Launching System.

This funding would include a Lunar Transport Vehicle development program that would give the U.S. the capability of using the moon and space. Then if the need should develop in the future, the Lunar Expedition Facility could be expanded to support military operations. Studies have shown that the moon possesses real military potential and it could support a recallable deterrent capability. The development of the Lunar Transport Vehicle represents a minimum program for the Air Force to obtain control of the cislunar volume and the lunar surface.

5.1 BUDGET ESTIMATE AND FINANCIAL PLAN

A preliminary design for the Lunar Transport Vehicle is presently being accomplished by six contractors on an active study program. This program was funded for \$300,000 in FY 61 and three of the contractors are each performing the design under a \$100,000 contract. The other three contractors are participating on a voluntary basis. The final reports for this preliminary design will be submitted to the SSD on 30 June 1961. Evaluation of these reports will follow immediately and the results will be used to revise this document where necessary. The LUNEX program has an Engineering Design competition scheduled for initiation in January 1962. This competitive effort would be evaluated and a decision on the manufacturing approach would be possible by January 1963. To accomplish this program the following funds will be required:

<u>Year</u>	<u>FY-62</u>	<u>FY-63</u>
\$	26.9	112.2

Should the above funds not be made available, the schedule for establishing the Lunar Expedition will be delayed proportionally to the delay in funding.





5.2 COST ESTIMATES

The funding requirements for the complete LUNEX Program are as follows:

F.Y. COSTS (In millions)

	1962	1963	1964	1965	1966	1967	1968	1969	1970	1971
R & D	26.9	104	335	660	1084	1608				
Launch Facilities		8	64	64						
Expedition Costs							1135	1023	798	631
Annual Total	26.9	112	399	724	1084	1608	1135	1023	798	631
Program Total										7541

To accomplish the LUNEX Program, additional information about the lunar surface is required at an early date. This means lunar surface photographs from a lunar orbiting vehicle and the delivery of a radio-light beacon to the lunar surface by a soft landing vehicle. Present NASA programs will provide some information and capability. However, to meet the LUNEX program schedule, the following additional funding will be required by either the NASA or the Air Force:

Unmanned Vehicles

F.Y. COSTS (In millions)

	1961	1962	1963	1964	1965	1966	1967
Lunar Photographs and Radio-Light Beacon	15	75	85	15			
Recovery of Lunar Core Sample	12	35	85	285	265	85	24
ANNUAL TOTALS	27	110	175	300	265	85	24



5.3 FY 62, 63 FINANCIAL PLAN

	\$ In Thousands	
	<u>FY-62</u>	<u>FY-63</u>
<u>MANNED LUNAR PAYLOAD</u>		
Lunex Re-entry Design & Mockup (2 cont'r, 8 M ea)	16,000	80,000
Lunar Landing Stage (2 cont'r, 1 M ea)	2,000	10,000
Lunar Launching Stage (2 cont'r, 1 M ea)	2,000	10,000
<u>SECONDARY POWER</u>		
Manned Vehicle Power System	600	1,000
Surface Vehicle Power System (15 kw)	100	300
Nuclear Lunar Facility Power (300 kw) (Spur Program Support)	1,000	1,500
<u>GUIDANCE</u>		
Mid-course System	200	450
Lunar Terminal System	300	450
Lunar Ascent System	100	300
Earth Return System	200	500
<u>LIFE SUPPORT</u>		
Crew Compartment Design	400	1,000
Ecological System	1,000	1,200
Moon Suit or Capsule	500	800
<u>COMMUNICATIONS & DATA HANDLING</u>		
Manned Vehicle Video System Design	400	1,000
Wide Band Moon-Earth Link Design	200	400
Secure Narrow Band Link Study	100	300
Man-Man Lunar Surface	300	650
<u>Materials and Resources</u>		
Re-entry Materials Research	1,000	1,300
Lunar Natural Resource Dev.	500	1,000
	<u>26,900</u>	<u>112,150</u>



SECTION VI

PROGRAM MANAGEMENT

LUNAR EXPEDITION (U)
(LUNEX)

6.1

WDLAR-S-458





RECORD OF CHANGES

CHANGE NO.	DESCRIPTION OF CHANGE	DATE OF CHANGE	REFERENCE TO BASIC PART

6.2

WDLAR-S-458





INDEX

TITLE PAGE 6.1

RECORD OF CHANGES 6.2

INDEX 6.3

6.0 MANAGEMENT FOCAL POINT 6.5

6.1 RESPONSIBILITIES 6.5

6.2 PROGRAM OFFICE MANNING 6.6

6.3 ORGANIZATIONAL RELATIONSHIPS 6.7

6.4 AIR FORCE DEVELOPMENT AND SUPPORT 6.7

6.5 OTHER AGENCIES 6.8

6.6 MANAGEMENT TOOLS 6.8

6.7 PEP 6.8





Intentionally Left Blank

6.4

WDLAR-S-458



[REDACTED]

6. PROGRAM MANAGEMENT

6.0 MANAGEMENT FOCAL POINT

The focal point for management of the Lunar Expedition Program will be a Lunex Program Office within the Space Systems Division, AFSC. The Director of the Program Office will coordinate, integrate, monitor and direct all activities of the Lunar Expedition Program. Subordinate to the Director will be managers for major parts of the program. A tentative organizational chart for the Program Office is shown in Figure 6-1.

6.1 RESPONSIBILITIES

a. The Earth Launch Complex Office will be responsible for the civil engineering aspects of building up the earth launch base. The immediate problem of this office will be a site selection survey.

b. The Earth Launch Vehicle Office will be responsible for all earth launch boosters required for this program.

c. The Lunar Landing and Launch Vehicles Office will be responsible for all development and testing of the Lunar Landing Stage and Lunar Launch Stage.

d. The Manned and Cargo Payloads Office will be responsible for the development of the 3-man Lunex Re-entry Vehicle and the Cargo Package. This will be one of the key offices in the entire program since it will be concerned with such major technical areas as life support equipment, re-entry problems, secondary power and structures.

e. The Communications and Data Handling Office will be responsible for establishing the communications network and centralized data handling organization. It will also concern itself with communications problems between the earth, the moon, and the Lunex Re-entry Vehicle and point-to-point on the lunar surface.

f. Guidance and Flight Control Office will be responsible for developing: ascent, mid-course, terminal, lunar ascent, and re-entry guidance equipment.

g. The Lunar Expedition Facility Office block (shown in dotted outline) indicates that that office will be established at a later time since the problems associated with the expedition facilities are not of immediate concern.

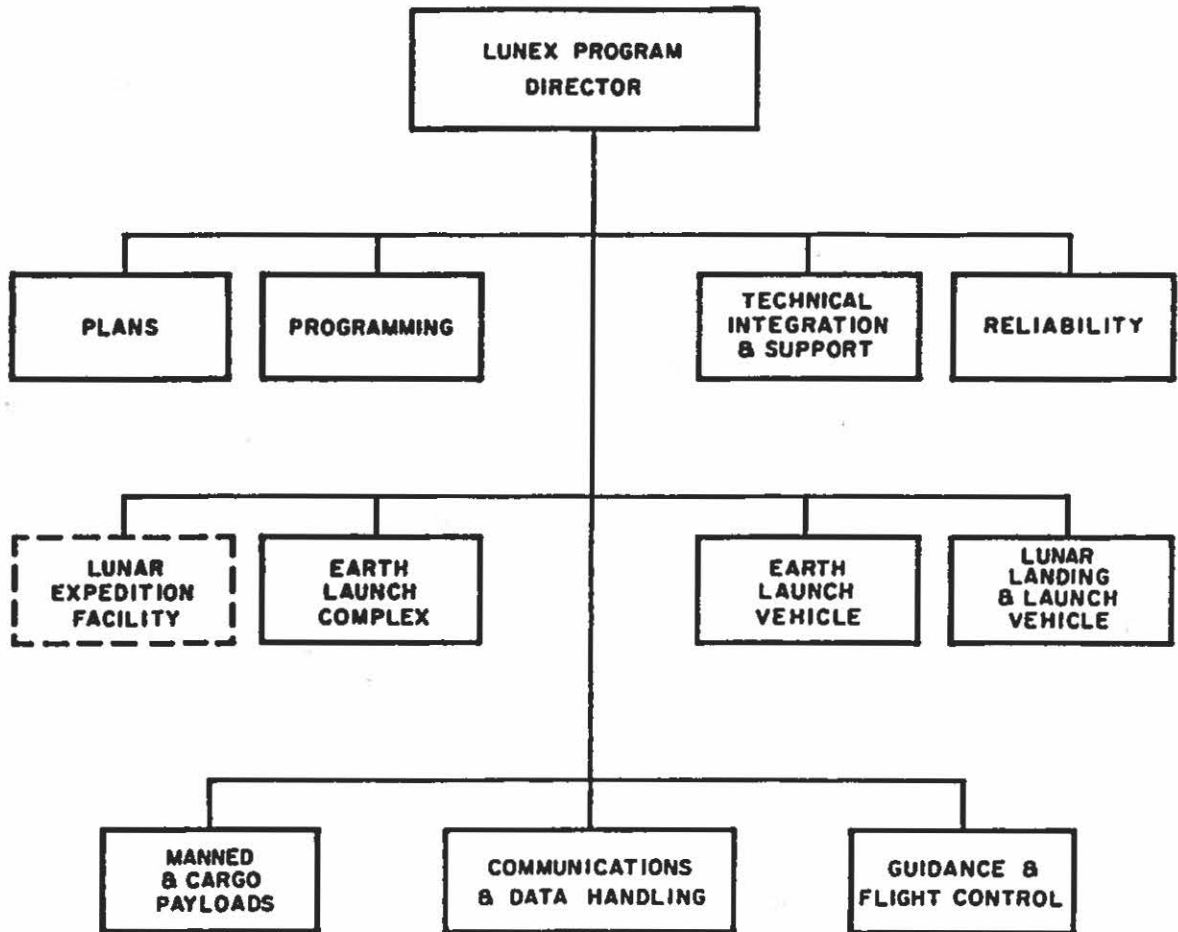


FIGURE 6-1 LUNEX PROGRAM OFFICE

WDLAR - S - 458

[REDACTED]

h. The Plans Office will be responsible for examining other potential uses of equipment developed for the Lunex Program. For example, the same equipment could be used for sending men around Mars and Venus, or perhaps effecting a landing on Phobos. Considerable planning also needs to be done regarding the exploratory phase of the Lunar Expedition.

i. Programming Office will be responsible for scheduling and budgeting of the entire program. This office will have under its control a network of computers designated as the MEP program.

j. The Technical Integration and Support Office will be responsible for insuring the technical compatibility of all components of the system, such as, that the vibration is within tolerable limits during the boost phase when all components of the system have been put together. This office will also provide technical assistance to each of the main component offices. The component office such as the Manned and Cargo Payloads Office will not rely entirely on the Technical Integration and Support Office for assistance, but will be free to obtain the best technical advice available in the nation from whatever source is necessary, such as other government laboratories or universities. This Technical Integration and Support Office will be manned by Air Force officers who will be responsible for the various disciplines and for technical support from the Aerospace Corporation.

k. The Reliability Office will insure that a strong reliability and safety program is followed by all contractors throughout the program. Since reliability and safety is of such extreme importance in this program every effort must be made to insure the reliability of the final equipment. This can only be done by giving proper recognition to the problem at a high organizational level where policies and recommendations can be recognized and implemented.

6.2 PROGRAM OFFICE MANNING

A Program Office must be established immediately after program approval if planned schedules are to be met. It is estimated that an initial buildup to 72 officers plus 35 secretaries will be required. A requirement for 100 MTS will be established with the Aerospace Corporation. In view of the magnitude of the program, which will build up to more than one billion dollars a year, a larger Program Office will be required. Planning for these increased manpower requirements will be accomplished by the Program Office, after it is established. Suggested initial distribution



of personnel within the Program Office is as follows:

- a. Lunex Program Director 4
- b. Plans 4
- c. Programming 6
- d. Technical Integration and Support 20
- e. Reliability 2
- f. Earth Launch Complex 5
- g. Earth Launch Vehicle 5
- h. Lunar Landing and Launch Vehicle 5
- i. Manned and Cargo Payloads 15
- j. Communications and Data Handling 3
- k. Guidance and Flight Control 3

6.3 ORGANIZATIONAL RELATIONSHIPS

There will be a continual and energetic exchange of direction and information between personnel of the Lunar Program Office and development contractors. Because of the complex nature and magnitude of the program, the Program Director will be required to deal with many contractors from diverse technical areas. It is envisioned that an associate contractor will be selected for each major portion of the program, who will, in turn, use many supporting contracting various technological capabilities. Technical integration and support will be accomplished by the Aerospace Corporation under the overall guidance and control of the Program Office.

6.4 AIR FORCE DEVELOPMENT AND SUPPORT

The Lunex program office will work with the Technical Area Managers within AFSC. The Technical Area Managers have project responsibility for development of solutions to technical problems such as those associated with guidance, materials, rocket engine propulsion, life support, etc. Each Technical Area Manager will identify and emphasize those critical technical problems to which specific effort must be directed in order to attain a capability required by the Lunex program.

6.7

WDLAR-S-458





6.5 OTHER AGENCIES

Specific arrangements will be made with other agencies as requirements arise in the development of the Lunex program.

6.6 MANAGEMENT TOOLS

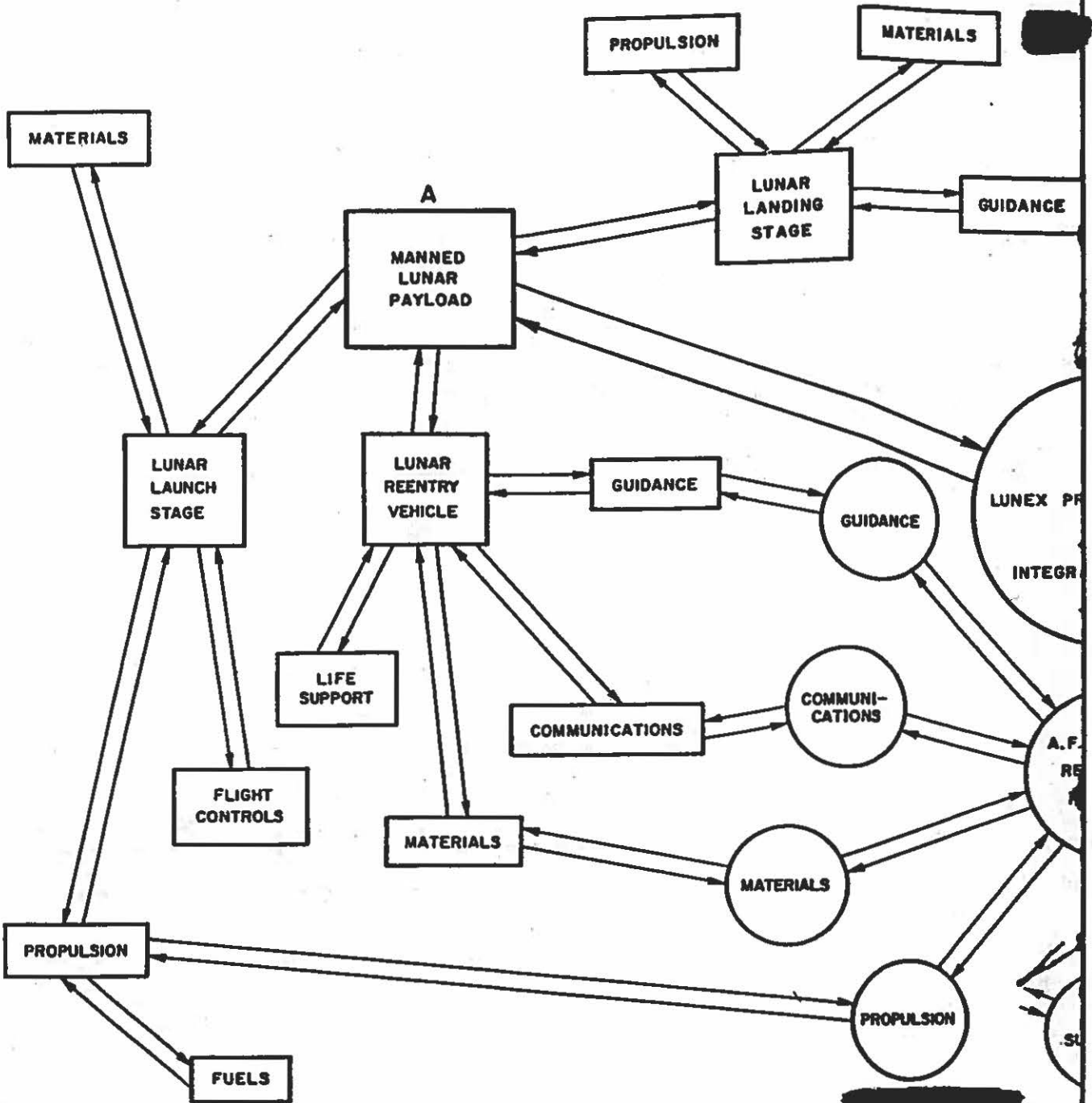
The basic philosophy of developing all elements of this program on a concurrent basis introduces rigid scheduling requirements. Specific tasks must be defined and scheduled. However, when development problems dictate that many factors be varied to keep abreast of advancing state-of-the-art, concurrency and even the end objectives are affected and possibly delayed. A management tool which uses an electronic computer will be used to support the Program Director in planning, operating, and controlling the Lunar Expedition Program. It will be initiated in the early stages of the Program and will continue to be used throughout the expedition phase. This management tool called Program Evaluation Procedure (PEP) will assist the Director by providing:

- a. A method of handling large masses of data quickly, efficiently and economically.
- b. The capability to locate, identify and this correct trouble spots.
- c. A capability of integrating the many varied and complicated facets of the Lunar Expedition Program.

6.7 PEP

The PEP management tool is made possible through the use of an electronic digital computer. The scheduling and monitoring of many thousands of items required in the Lunar Expedition Program make the use of this computer technique imperative. The PEP approach employs linear programming techniques with a statistical concept in conjunction with the electronic computer. This procedure facilitates the analysis of interrelationships of many thousands of program elements. The results are presented as program summaries upon which the Director can base decisions. (See Fig. 6-3)

The first step in using the PEP management tool is to make a detailed analysis of the overall Lunex Program. Each major event, milestone, or accomplishment that must be achieved is listed in chronological order. The events must be well defined and should occur at an instant of time which can be identified. A network, or a program plan chart, is laid out in which the events are shown as points or circles whose positions roughly represent their chronological order. Interrelationships between the events (circles)



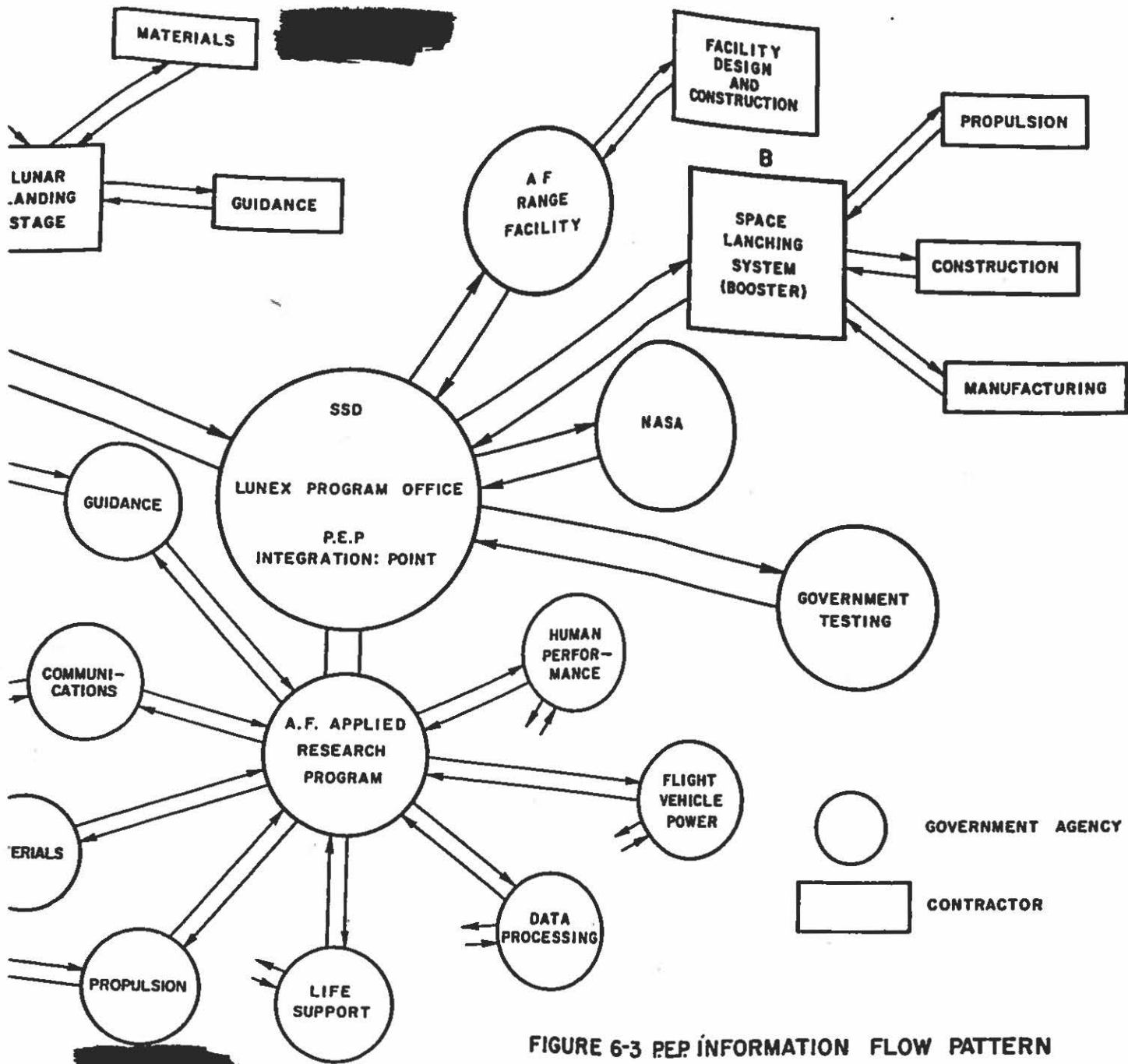

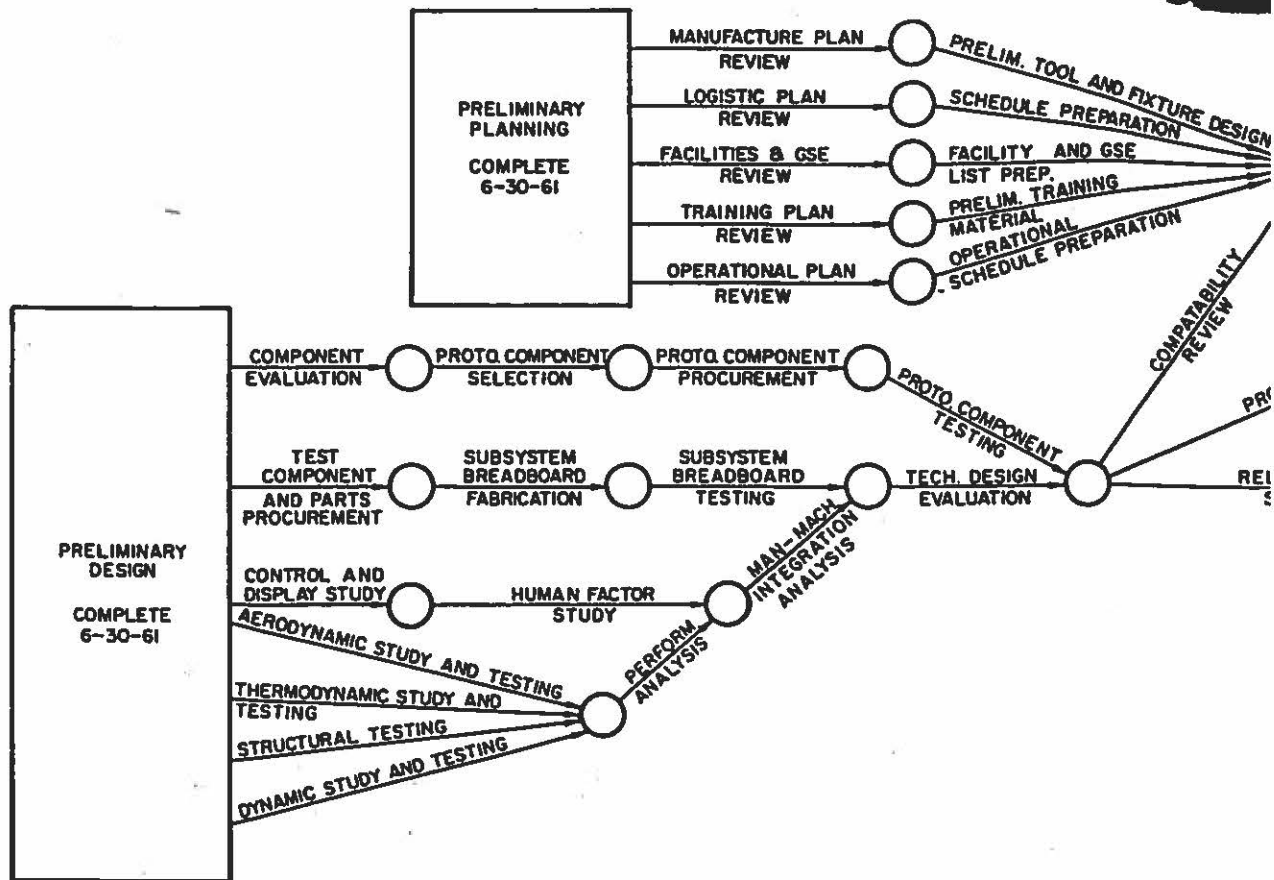


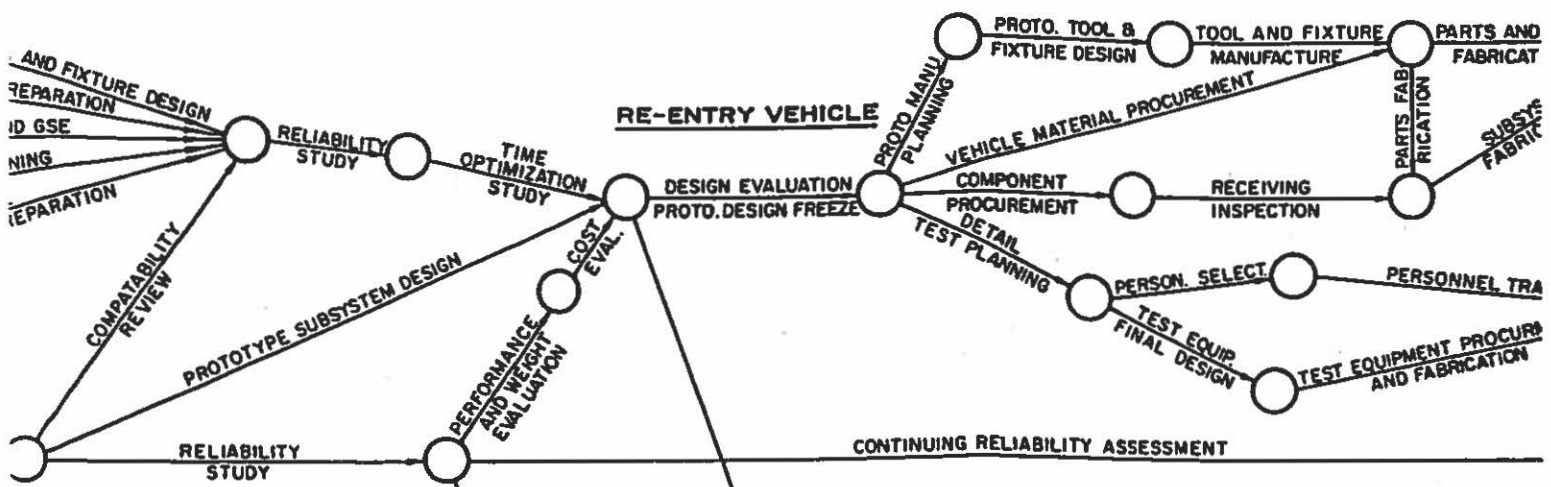
FIGURE 6-3 PEP INFORMATION FLOW PATTERN



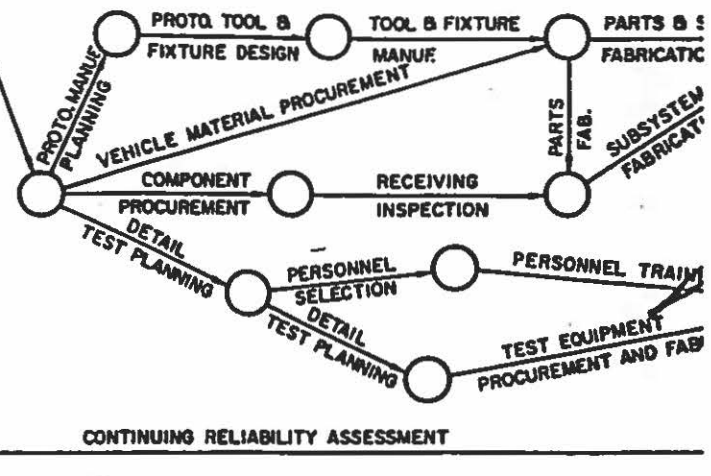
and sequence of events are shown by connecting lines. The line between the events represents work that must be done to proceed from one event to the next (See Figure 6-4). The computer then totals all of the expected activity times along every possible (in the thousands) route of the network from start to the end event. The PEP computer then examines the total times of the large number of paths in order to find the longest which is called the critical path. The critical path defines the sequence of events which will require the greatest expected time to accomplish the end event.

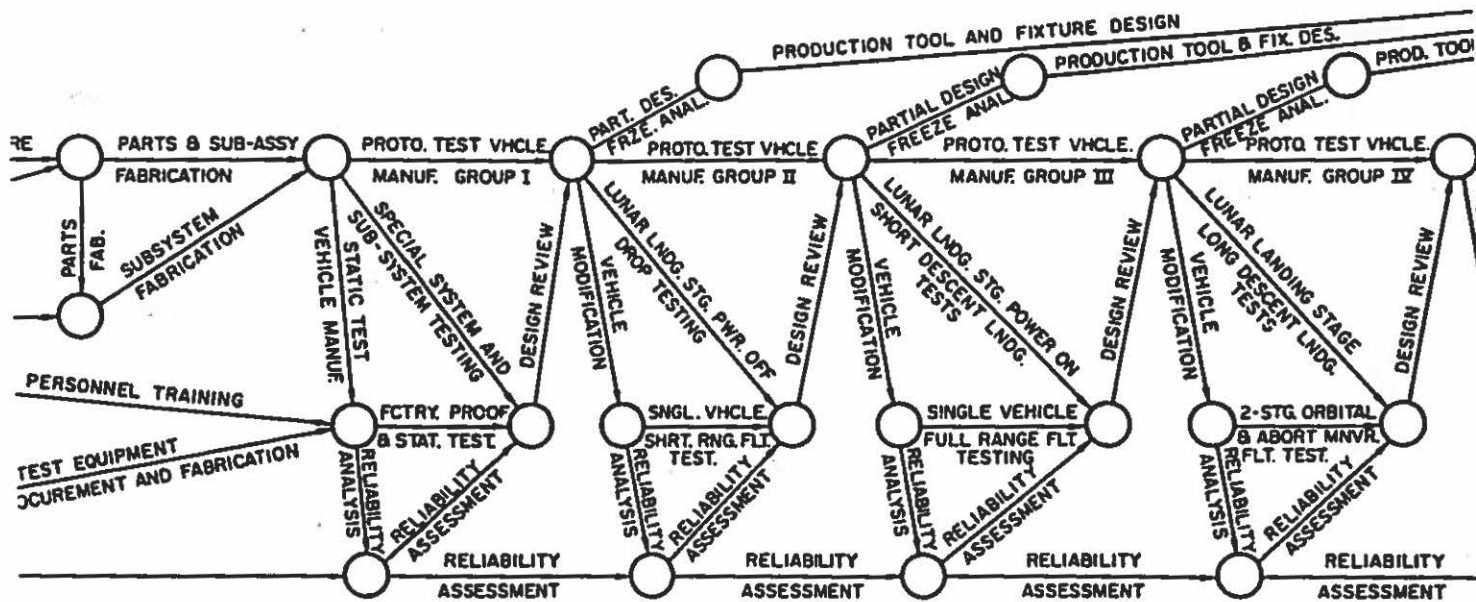
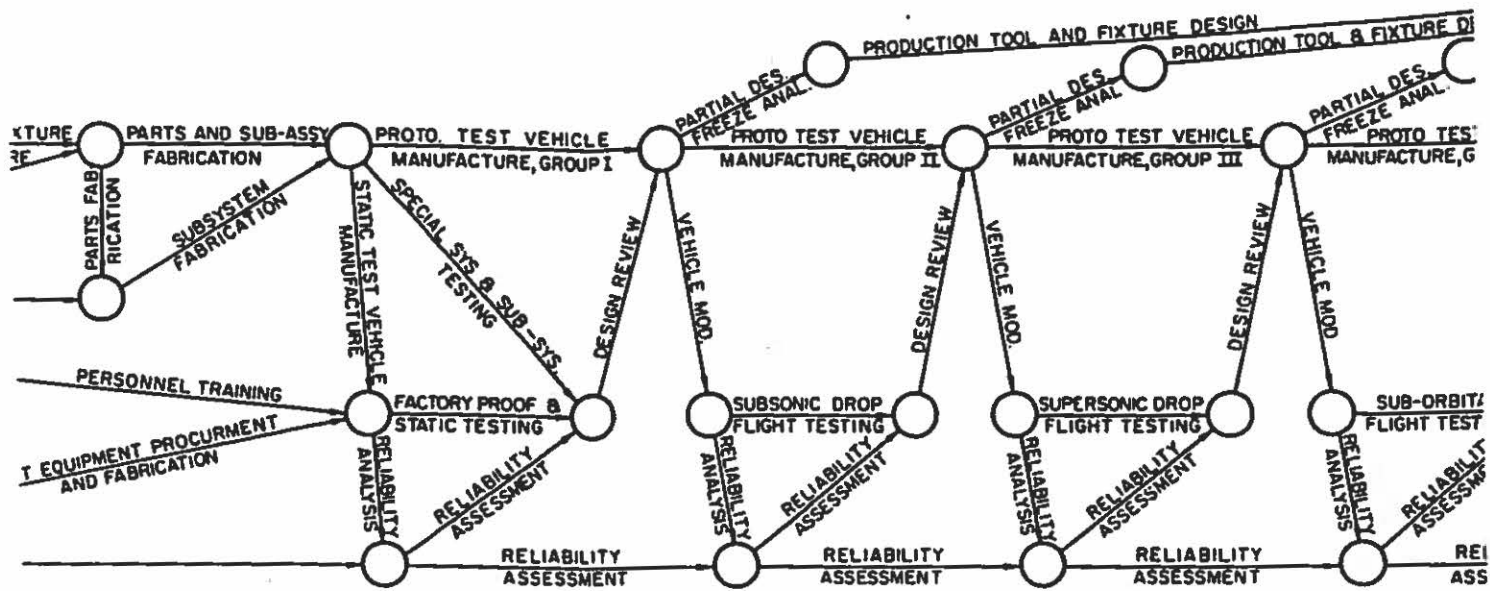
The effects of a delay for any particular milestone or event on the entire program or on any other event can be quickly and efficiently determined so that corrective action can be taken if required.





**LUNAR LAUNCH STAGE
LUNAR LANDING STAGE
DESIGN EVALUATION,
PROTOTYPE DESIGN FREEZE**





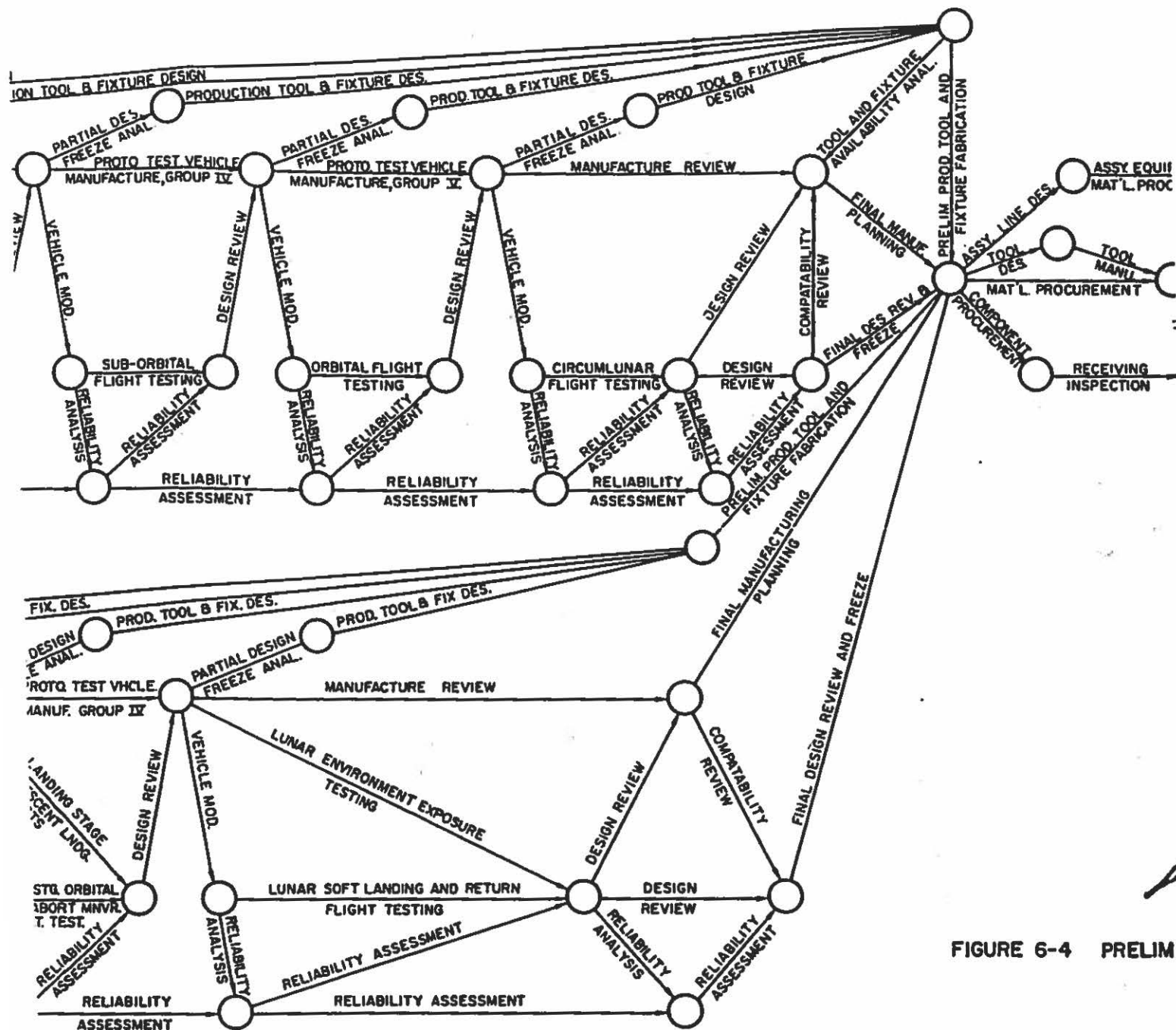


FIGURE 6-4 PRELIMIN

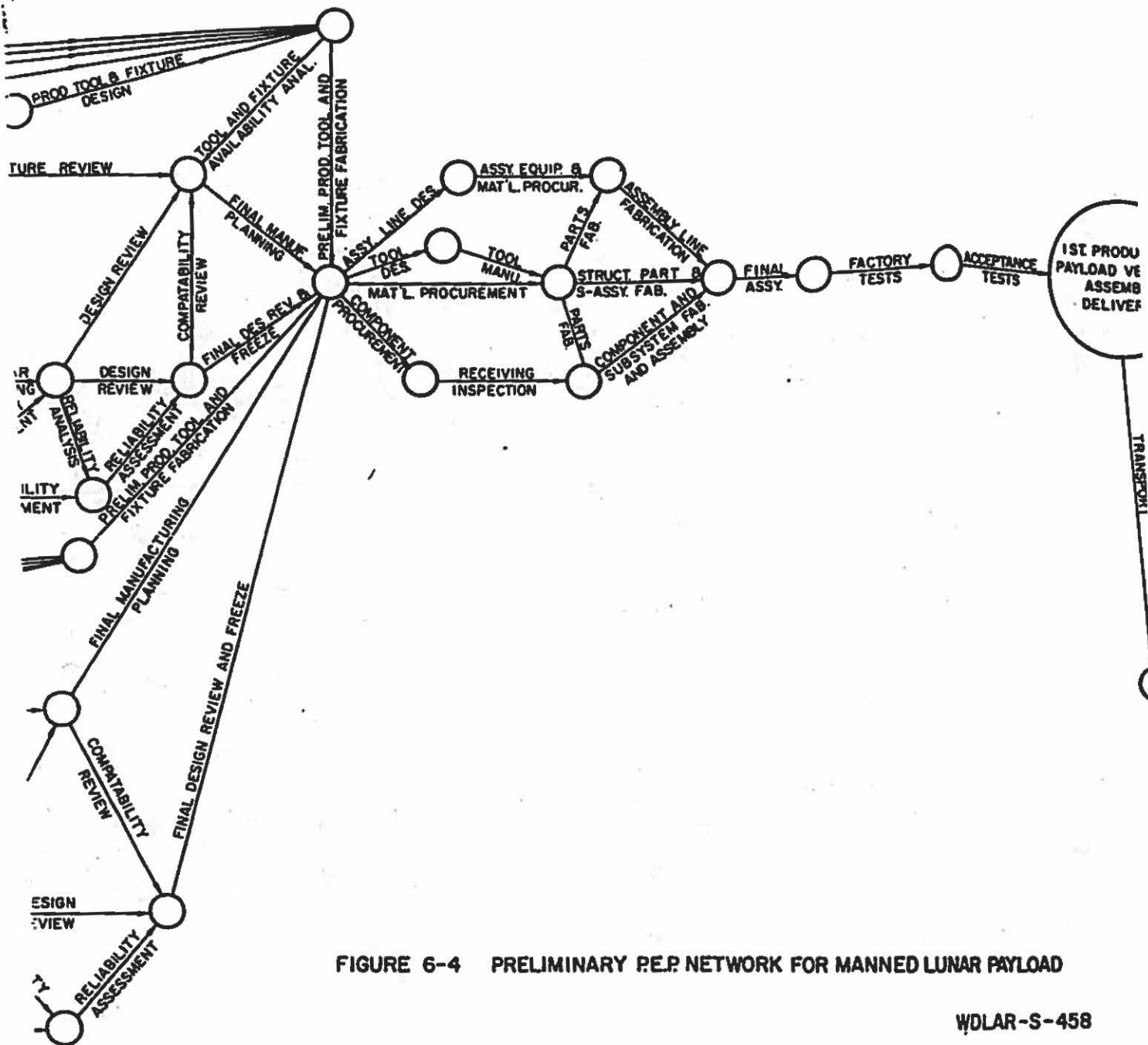
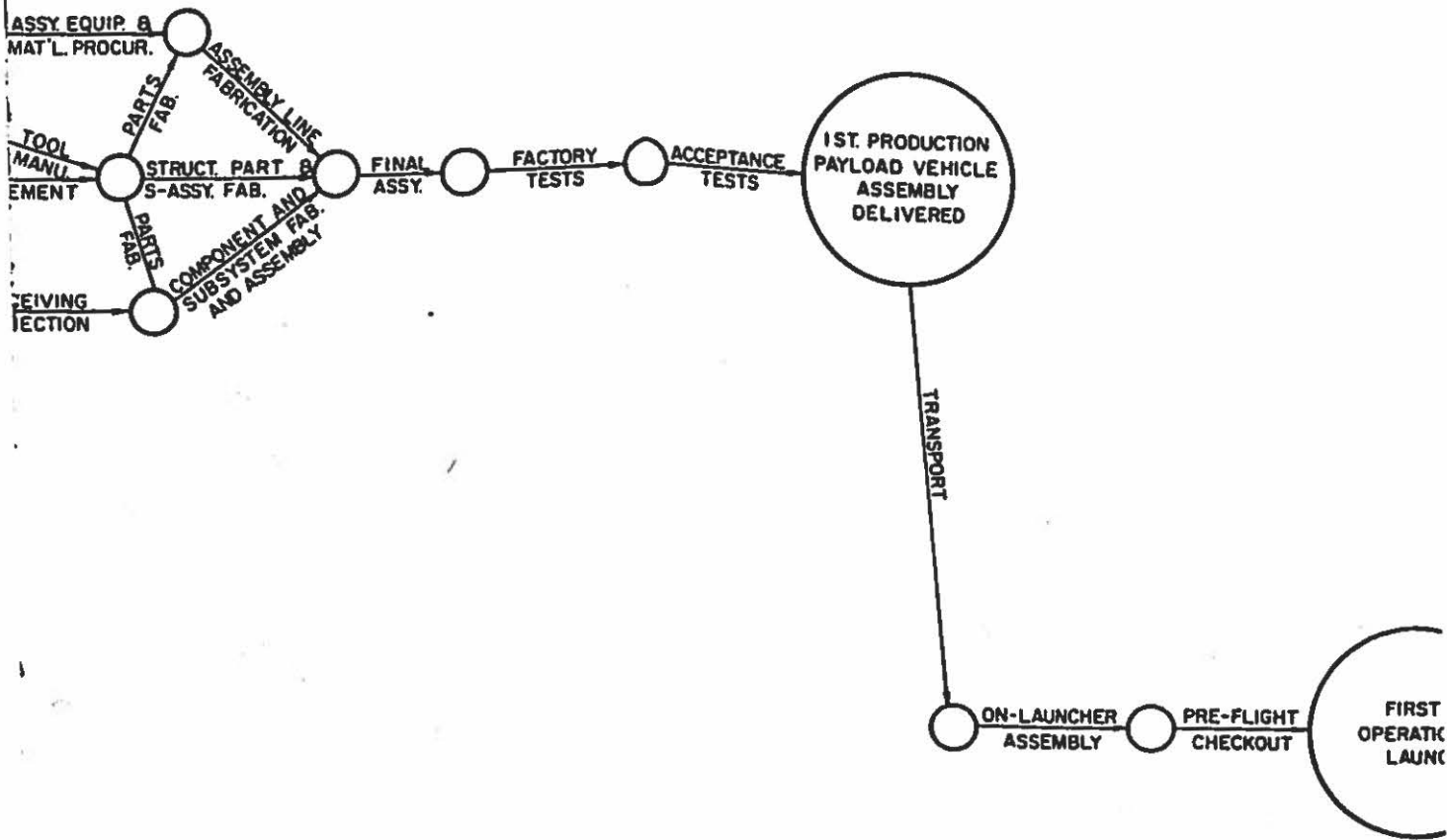


FIGURE 6-4 PRELIMINARY P.E.P. NETWORK FOR MANNED LUNAR PAYLOAD

WDLAR-S-458



PRELIMINARY P.E.P NETWORK FOR MANNED LUNAR PAYLOAD

WDLAR-S-458



SECTION VII

MATERIEL SUPPORT

LUNAR EXPEDITION (U)

(LUNEX)

7.1

WDLAR-S-458



[REDACTED]

RECORD OF CHANGES

CHANGE NO.	DESCRIPTION OF CHANGE	DATE OF CHANGE	REFERENCE TO BASIC PART

7.2

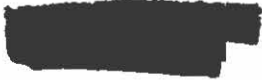
WDLAR-S-458



INDEX

TITLE PAGE	7.1
RECORD OF CHANGES	7.2
INDEX	7.3
7.0 INTRODUCTION	7.5
7.1 SUPPLY	7.5
7.2 DISTRIBUTION	7.7
7.3 STORAGE	7.7
7.4 REAL PROPERTY INSTALLED EQUIPMENT (RPIE)	7.8
7.5 MAINTENANCE	7.8
7.6 MANUFACTURING FACILITY CRITERIA	7.8





Intentionally left blank.

7.4

WDLAR-S-458





7. MATERIEL SUPPORT

7.0 INTRODUCTION

It is intended that this program use two significant concepts that will result in better management of the materiel support program. These are the Delayed Procurement Concept and the Responsive Production Concept. Under the Delayed Procurement Concept, the ordering and delivery of high-cost insurance-type spares is deferred until the final production run must be made, allowing for the accumulation of maximum operational experience with the new item before a final spares order must be placed. Under the Responsive Production Concept, a portion of the requirement for high-cost operational spares is procured in unfabricated, unassembled form. When the spares demand can be more reliably predicted, based on actual usage experience, additional complete spare items can be produced within a very short lead-time period. When experience fails to justify a requirement for additional complete spares, the materiel and parts involved can be utilized in end article production. The policy shall be to buy minimum quantities of high-value spares and maintain close control over their transportation, storage, issuance, and repair until they finally wear out, or are no longer required. Simplification of procedures and relaxing of restrictions on low-value items will provide the means (man-power, machine time, etc.) for more precise management of high-value items.

7.1 SUPPLY

Maximum utilization will be made of existing assets. Where practical, equipment and parts will be reclaimed from completed test programs, repaired, modified and overhauled to suitable condition for use in later tests and operational tasks. The procedures and paperwork involved with procurement of spare parts must be streamlined to permit maximum flexibility in planning and responding to a continually changing configuration. Immediate adjustment of inventories and reorder points must result from test program and engineering changes. Selection of spare parts should be made at the time of initial design to enable procurement of spare and production parts concurrently to eliminate reorder costs resulting from separate procurements.

[REDACTED]

Determination of quantities, reparable-overhaul-modification planning, control etc., shall be accomplished and directed by a permanently organized and active group composed of personnel representing the engineering, production, materiel, reliability, quality control, procurement and contract departments, and the various affected sections within these departments such as design, test, planners, etc., attending as required. The AFPR will have a member assigned to this group for surveillance purposes and to provide logistic guidance on problems which may require advice from the Air Force.

Persons assigned to the group shall be well qualified by reason of experience and technical ability.

The procedures and paperwork involved shall be streamlined, taking due cognizance of the powers and capabilities of the above group to permit maximum flexibility in planning and the quickest possible response to changes and emergency situations.

The group will pay particular attention to control of hi-value items and items critical to the needs of the expedition and test program. Such items, particularly those potentially subject to imminent redesign, will be rigorously screened to assure economical inventory and the best possible repair, overhaul and modification planning at all times.

The group shall be responsible for the following:

a. Immediate adjustment of inventories and reorder points resulting from changes to the delivery schedule, the test program, and for engineering changes.

b. Inventory review and adjustment of initially established stock levels and/or reorder points in light of latest experience gained from the test program every time reorder or minimum stock levels are reached.

c. Review of stock levels, and adjustment and/or disposition of non-moving items on a continuing basis, but at intervals not to exceed sixty (60) days for any individual hi-value items and 180 days for other items, or at other intervals as agreed upon by the Contractor and the Contracting Officer. This is to include the return to production of any surplus quantities for rework to later design requirements.

[REDACTED]

d. Control of repair-overhaul-modification planning.

7.2 DISTRIBUTION

The Contractors shall develop internal working procedures which encompass the following requirements:

a. Inventory levels shall be programmed to vary with anticipated utilization. Shipments in advance of estimated requirements will not be made except when it is clearly in the best interest of the program to do so.

b. Stock levels shall be minimized by maximum economical reliance on repair, overhaul, and modification of reparable items. Repair, overhaul, and modification turn-around time will be a prime determinant in establishing the minimum stock-level period for each item.

c. Where feasible (with particular emphasis on hi-value and critical items), inventory cost will be minimized by stockage of repair, overhaul and modification bits, pieces and components (relatively low-cost items) in conjunction with a pre-planned and flexible expedited repair, overhaul, and modification program, as opposed to stocking sub-assemblies and end items themselves (the relatively high-cost items).

d. Stock levels will be determined on basis of overall program needs and will be independent of the site location of the stock. Maximum utilization will be made of available contracted air transportation to minimize "pipeline" time.

7.3 STORAGE

Parts whether required for the test or expedition programs should not be segregated from production stock. This merely adds an unnecessary stockage cost-burden. By combining storage facilities with a co-mingling of stock, considerable cost savings can be effected. Spares and production stock serve as buffer stocks for each other. If multiple activities such as manufacturing, test, and the expedition are supplied from a single storage facility the chance of stockout would be

[REDACTED]

minimized.

7.4 REAL PROPERTY INSTALLED EQUIPMENT (RPIE)

Each contractor is charged with the responsibility of identifying, as well as determining the criteria for all items required for successful mission accomplishment. When the requirements have been determined the responsibility for accomplishing the required RPIE materiel support program will be assigned. This materiel support will include the necessary selection of spare parts to be stored at the manufacturing facility or at the launch site.

7.5 MAINTENANCE

The proposed operational mode of the LUNEX program is unique in that it retains all the features of a research and development program. In the time period designated as "expedition", it can be expected that in addition to a variety of missions the systems will be modified and improved, the launch facilities and support equipment may require modification, and technical development may force program changes. Since the expedition period is actually a continuation of the development and test program it is apparent that the systems and techniques developed during testing may also be continued for the Expedition.

An evaluation will be made to determine the feasibility of having contractors support the program throughout its entire life. However, in determining the total task, consideration must be given to the available Air Force manpower, equipment and facilities that may be used to support the LUNEX program.

7.6 MANUFACTURING FACILITY CRITERIA

The equipment production facilities will preferably consist of an existing large aerospace plant convertible to LUNEX production with a minimum modification program. It may be necessary to find a facility that is adjacent to, or easily accessible to navigable waterways. The facility should obviously be located in an area containing an abundance of skilled manpower. Manufacturing Test Facilities adjacent to the manufacturing facilities would be very desirable to reduce transportation problem.

7.8

WDLAR-S-458

[REDACTED]

[REDACTED]

Certain items, such as the large liquid and solid boosters and propellant, will probably be assembled at the Lunex Launch Complex and special facilities for manufacturing these items will be required at the launch complex. Thus checkout and acceptance test facilities will also be required at the launch complex.

Many major manufacturing items, such as the Lunar Landing Stage and the Lunar Launch Stage, will be produced at the manufacturers' facility. This will require propellant storage, or a propellant manufacturing capability at the plant, plus various test and check out facilities to support manufacturing.

As an example, the following test facilities will be required to support the manufacturing of the Lunar Landing and Lunar Launching Stages:

a. Configuration--For each of the two stages a Propulsion Test Vehicle Test Stand and two Flight Acceptance Firing Stands will be required. In addition, cold flow test facilities consisting of one pad and three structural towers will be required.

Two separate test complexes will be needed - one for each of the two stages. There will be only one centrally located blockhouse with control and instrumentation capability for operating both complexes. Each hot firing stand would be located in accordance with a 2 psi explosion overpressure criteria. An explosive force calculated on equivalent LH_2 caloric content to TNT, shows that the hot stands should be no closer than 2000' to any other hot or cold stand.

b. Test Pad Configuration and arrangement - - Each hot test pad will consist of a concrete pad containing the launcher structure. The stage is erected by a mobile commercial type crane, and personnel access for maintenance is by work stand and ladders, or a cherry picker. No service tower will be required.

c. Thrust Level Measurement - - Thrust levels will be determined by measuring the chamber pressure and applying the result to the engine manufacturer's calibration curve. Tanking level is determined by the Propellant Utilization System.

[REDACTED]

d. Altitude Simulation Unit - - A plenum chamber, containing steam jets up stream of its exhaust bell, shall be attached to each engine for altitude simulation.

e. Flame Deflector - - The design is a conventional configuration elbow shaped shield cooled with a firex water injection system.

f. Propellant Storage and Handling Equipment - - A central LO_2 storage and transfer facility shall be provided for each of the two test facilities. The Lunar Landing Stage facility shall store 350,000 lbs. of LO_2 . Spherical, vacuum insulated dewars shall be used. The transfer unit shall be a motor operated centrifugal pump with 500 gpm and 100 psi discharge head capacity. The Lunar Launch Stage Test Facility LO_2 storage shall contain 18,000 gallons in spherical dewars with a transfer pump capability of 200 gpm and 100 psi discharge head. Distribution lines for both complexes would be prefabricated, static vacuum, insulated steel pipe.

An LH_2 storage and transfer facility will be provided at each hot firing test stand and the cold flow test pad. The transfer system is an LH_2 gas generator system with air being the thermal source. Pressuring level in each tank would be 100 psi. The LH_2 storage capacity requirement for each Lunar Launch Stage facility is 15,000 lbs. and at each Landing Stage Site is 35,000 lbs. Again the storage facilities would be spherical dewars with segmented, prefabricated, static vacuum insulated stainless steel pipe distribution lines.

VII
CIVIL ENGINEERING



SECTION VIII

CIVIL ENGINEERING

LUNAR EXPEDITION (U)

(LUNEX)

8.1

WDLAR-S-458





RECORD OF CHANGES

CHANGE NO.	DESCRIPTION OF CHANGE	DATE OF CHANGE	REFERENCE TO BASIC PART





INDEX

TITLE PAGE	8.1
RECORD OF CHANGES	8.2
INDEX	8.3
8.0 INTRODUCTION	8.5
8.1 LUNAR LAUNCH COMPLEX	8.6
8.2 LOGISTICS	8.7
8.3 AEROSPACE GROUND ENVIRONMENT	8.7





This page intentionally left blank

8 .4

WDLAR-S-458





8. CIVIL ENGINEERING

8.0 INTRODUCTION

As part of the Lunar Transport Vehicle study, consideration was given to the facilities required for the launch and support of the Space Launching System and the Lunar Payloads. It was assumed that the manufacture of all boosters and the payload would be accomplished at existing factories. Facilities and equipment required for the manufacture of large boosters may be readily installed at factories having clearance sufficient to handle the booster. Large boosters such as required for this program must necessarily be transported over long distances by specially constructed barges. By selecting manufacturing facilities and launch sites adjacent to navigable waters, a minimum of overland transport would be required. A significant savings may be effected by providing launch capabilities at selective areas where existing support facilities, personnel housing, and assured tracking capabilities are available.

The logistic support for the launch rates indicated in this plan dictates that new propellant manufacturing facilities be constructed at the launch site and that transport barges and other vehicles be available to transport vehicle components from the manufacturing plants.

A modified Integrated Transfer Launch System is envisioned for the Lunar Transport Launch System. The size and weight of the Space Launching Vehicle, designated the BC2720, precludes the transfer of the entire Lunar Transport Vehicle after assembly, but the integrated transfer of upper stages and lower stages separately with a minimum mating and checkout on the launch pad may provide increased reliability and appreciable cost saving.

In order to achieve the highest launch pad utilization possible and to make maximum use of specialized capital equipment and highly skilled manpower, the application of operations research technology will be required. To handle the test load and the complex sequencing requirements presented by the three-stage Space Launching Vehicle plus the Lunar Payload, a computer controlled, integrated launch sequencing and checkout system will be needed. It is desirable to accomplish the maximum amount of systems testing in a protected environment prior to locating the vehicle on the launch pad, and to use the launch pad, in so far as is possible, for its prime purpose, that of preflight servicing and launching the vehicle.

8.1 LUNAR LAUNCH COMPLEX

The Lunar Transport Vehicle System has a requirement for launch and support facilities suitable for manned lunar flight of a vehicle using a BC 2720 Space Launching System. Investigation of the launch pad requirements for a launch rate of two per month indicates that from 4 to 6 launch pads would be necessary depending on the launch site location and the means available for handling the booster. There are no existing launch pads capable of handling this vehicle, nor are there, at this time, facilities capable of conducting static testing of the "C" booster and the launch of the complete Lunar Transport Vehicle. It is possible that by combining the capabilities for both static firing and launch in two of the pads required, a significant cost saving may be gained and an accelerated test program may be effected. This would provide a capability for the launch of the "C" booster with or without solid boost during R&D flight test and for early test missions of the Lunex Re-entry Vehicle. The development and flight test of the "B" booster is planned at AMR during the development program.

It was assumed in the Lunar Transport Vehicle study that the manufacture of all boosters and the payload would be accomplished at existing factories. New and added facilities and equipment such as large forming brakes, special welding jigs, fixtures and machines, and large processing facilities would be required. In plants of sufficient size these facilities and equipment could readily be installed. Further investigation comparing the relative economics of manufacture at the launch site versus manufacture at existing facilities is required to insure an economical choice.

Assemblies having a diameter exceeding 12 feet or weighing over 200,000 pounds cannot be transported over United States railways. A load of 78,000 pounds is considered to be the limit over selected highway routes. In as much as both the "B" and "C" boosters of the Space Launch Systems have diameters in excess of 14 feet, transport from manufacturing plant to the launch site must be by barge. The large quantities of boosters and the special environmental protection required suggest that specially designed barges be constructed to transport these assemblies. Harbors and docking facilities would be required near the manufacturing facility and at the launch site.

By locating the launch facilities at or near Cape Canaveral for an easterly launch significant savings may be

[REDACTED]

effected. The use of existing administrative capabilities, personnel housing, assured tracking facilities, and technical support areas will provide a saving in costs and in leadtime required for construction of support facilities. Similar gains may be made by locating launch facilities at Point Arguello for polar launch. This does not mean that Cape Canaveral and Point Arguello are the only reasonable locations for the launch site. In fact, by extending the Atlantic Missile Range in a westerly direction across the Gulf of Mexico it is conceivable that a launch site in the vicinity of the Corpus Christi Naval Air Complex would provide the full use of AMR Range facilities with minimum overfly of foreign land masses. Likewise, extension of the AMR Range in a northerly direction to the coast of South Carolina would provide a similar accommodation.

8.2 LOGISTICS

The logistic support for the launch rates indicated in this study dictates that new propellant manufacturing plants be constructed at the launch site. Existing propellant manufacturing plants are inadequate and the launch rates mentioned would use the full capacity of a separate propellant manufacturing facility.

a. Propellant use rates for a 2 per month launch rate are estimated as follows:

- | | |
|---|---------------------------|
| (1) Liquid Hydrogen manufacture | 50 tons per day. |
| (2) Liquid Hydrogen storage
@ launch pad | 1.5×10^6 pounds. |
| (3) Liquid Oxygen/Nitrogen
Manufacture | 120 tons per day. |
| (4) Liquid Oxygen storage
@ launch pad | 4×10^6 pounds. |

Barges will be required for transport of boosters from the manufacturing plant to the launch complex.

8.3 AEROSPACE GROUND ENVIRONMENT

A modified Integrated-Transfer-Launch System is envisioned for the Lunar Transport Launch System. This approach would allow the complete integration and checkout of the "B" booster together with the Lunar Transport Payload in a protected

[REDACTED]

environment simultaneously with the assembly and checkout of the C2720 booster combination at the launch pad. The size and weight of the BC2720 Space Launching Vehicle precludes the transfer of the completely assembled Lunar Transport Vehicle from an integration building to the launch pad. It is feasible, however, to mate and integrate the "B" booster with the Lunar Transport Payload inside the protected environs of an integration building and when completed transfer the "B" booster and payload assembly to the launch pad for mating with the C2720 assembly. (See Figures 8-1 and 8-2). This can best be accomplished by a cliffside location or extending a ramp from the integration building to an elevation at the launch pad approximately equal to the height of the C2720 stage. The assembly and checkout of the "C2720" vehicle may be accomplished in two ways depending on the specific location of the launch pad and its accessibility to navigable waters. For a launch pad having no direct access to navigable waters, the assembly and mating of the solid segmented motors to the "C" booster would be accomplished at the launch pad. The extended time necessary to accomplish this assembly and checkout accounts for the difference in the numbers of pads required. It is estimated that 6 launch pads would be needed for this plan. For a launch pad having direct access to navigable waters, the assembly and mating of the solid segmented motors to the "C" booster could be accomplished at an interim integration building located some distance away from the launch pad. After assembly and checkout, the "C2720" combination would be transported by a barge to the launch pad and mated to the "B" booster and payload assembly. By using this approach it is estimated that 4 launch pads would be adequate for the 2 per month launch rate. Final confidence checks and integration of the booster and facility interface would be accomplished at the launch pad.

The TNT equivalent of vehicle propellants was estimated in the following manner. The TNT equivalent of the liquid propellants was taken at 60% of the total LOX/LH₂ load for all stages. This is the figure currently used at AMR for TNT equivalence for LOX/LH₂. In this case, because of the great quantities of propellant involved, this degree of mixing is unlikely and the 60% figure would be conservative. Solid propellants are taken at 100% of the propellant weight. It is also considered that detonation of the solid propellants may cause the subsequent detonation of liquid propellants and vice versa: but, the simultaneous detonation of all propellants

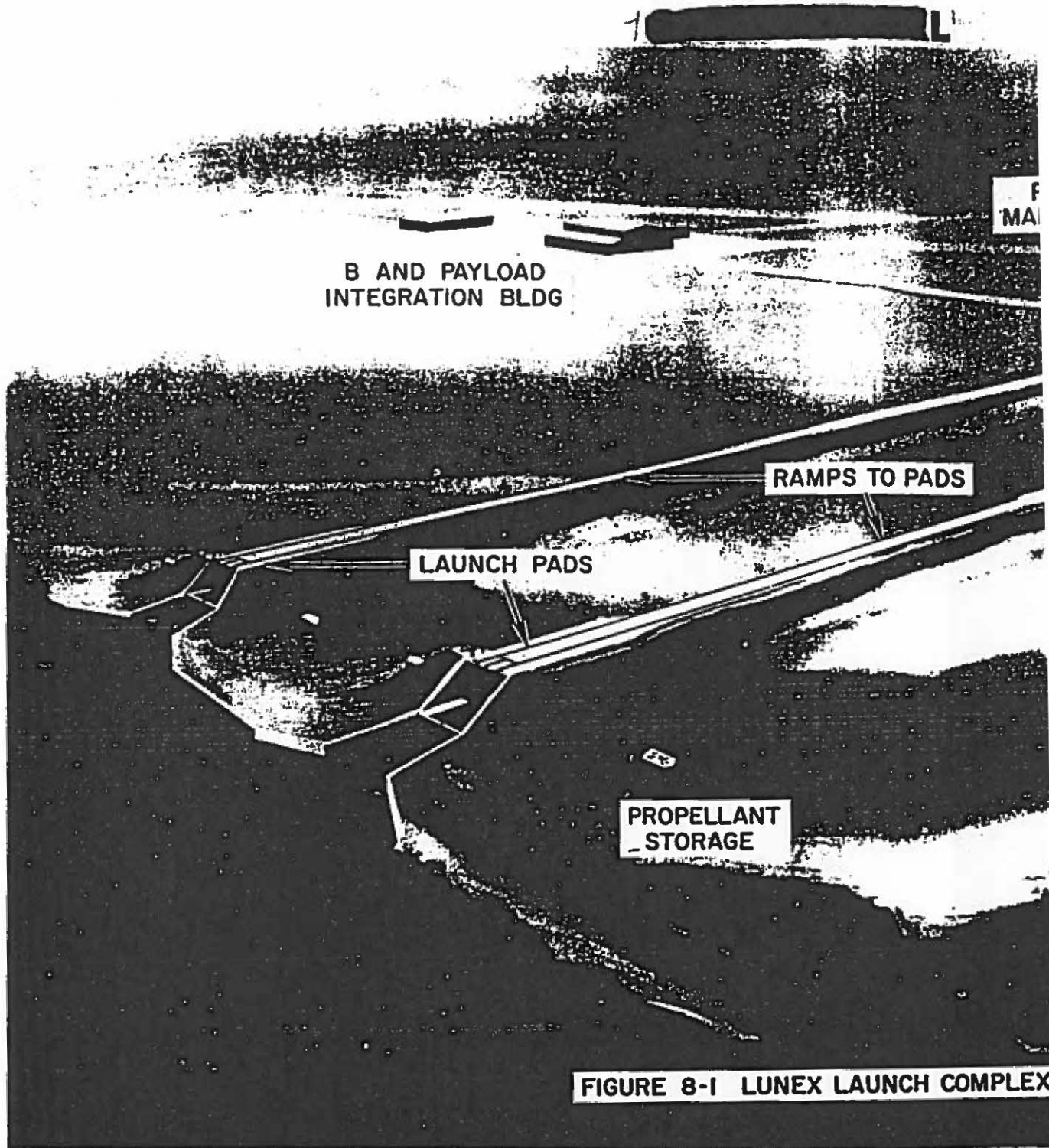
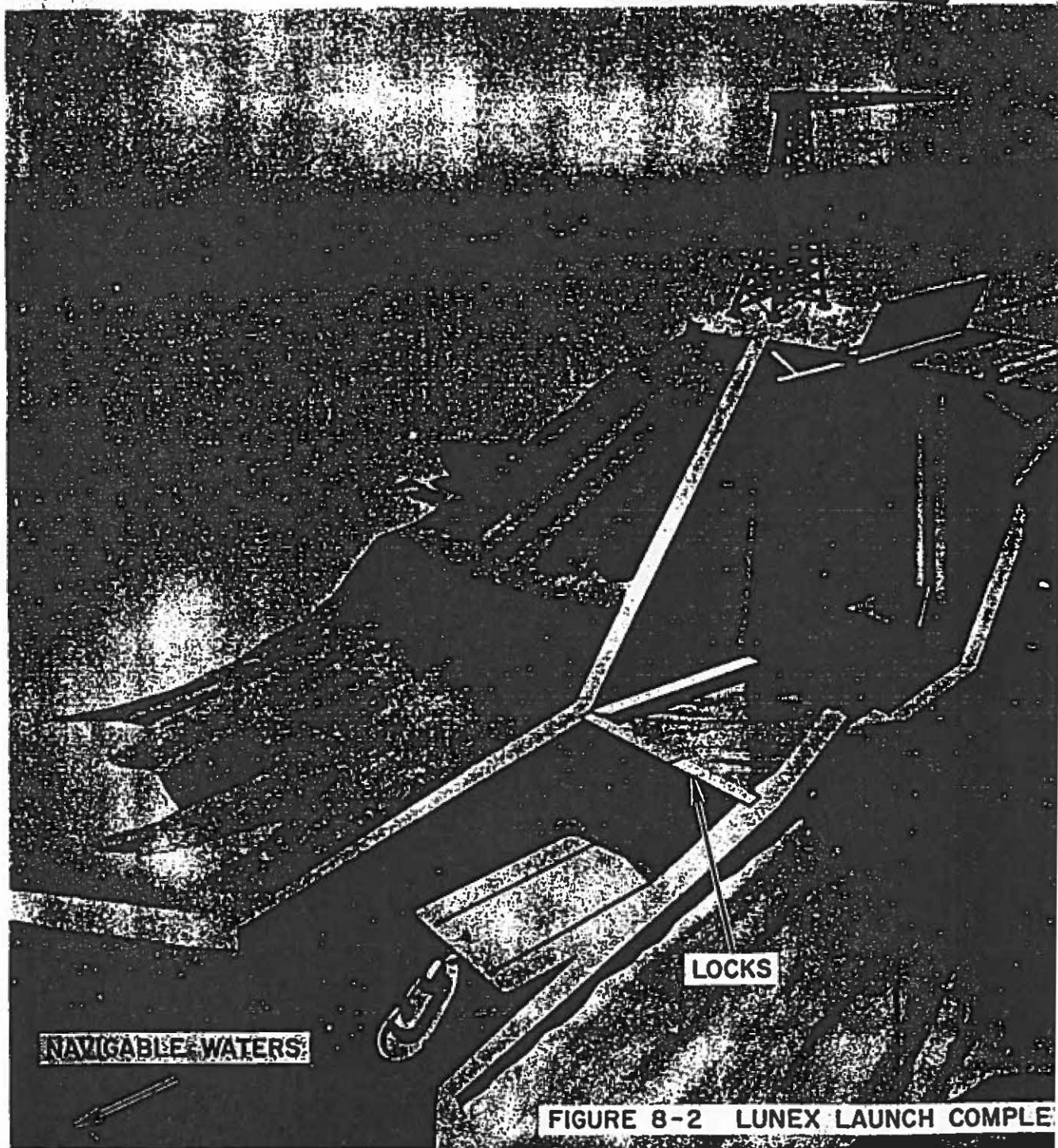


FIGURE 8-1 LUNEX LAUNCH COMPLEX



FIGURE 8-1 LUNEX LAUNCH COMPLEX



NAVIGABLE WATERS:

LOCKS

FIGURE 8-2 LUNEX LAUNCH COMPLE

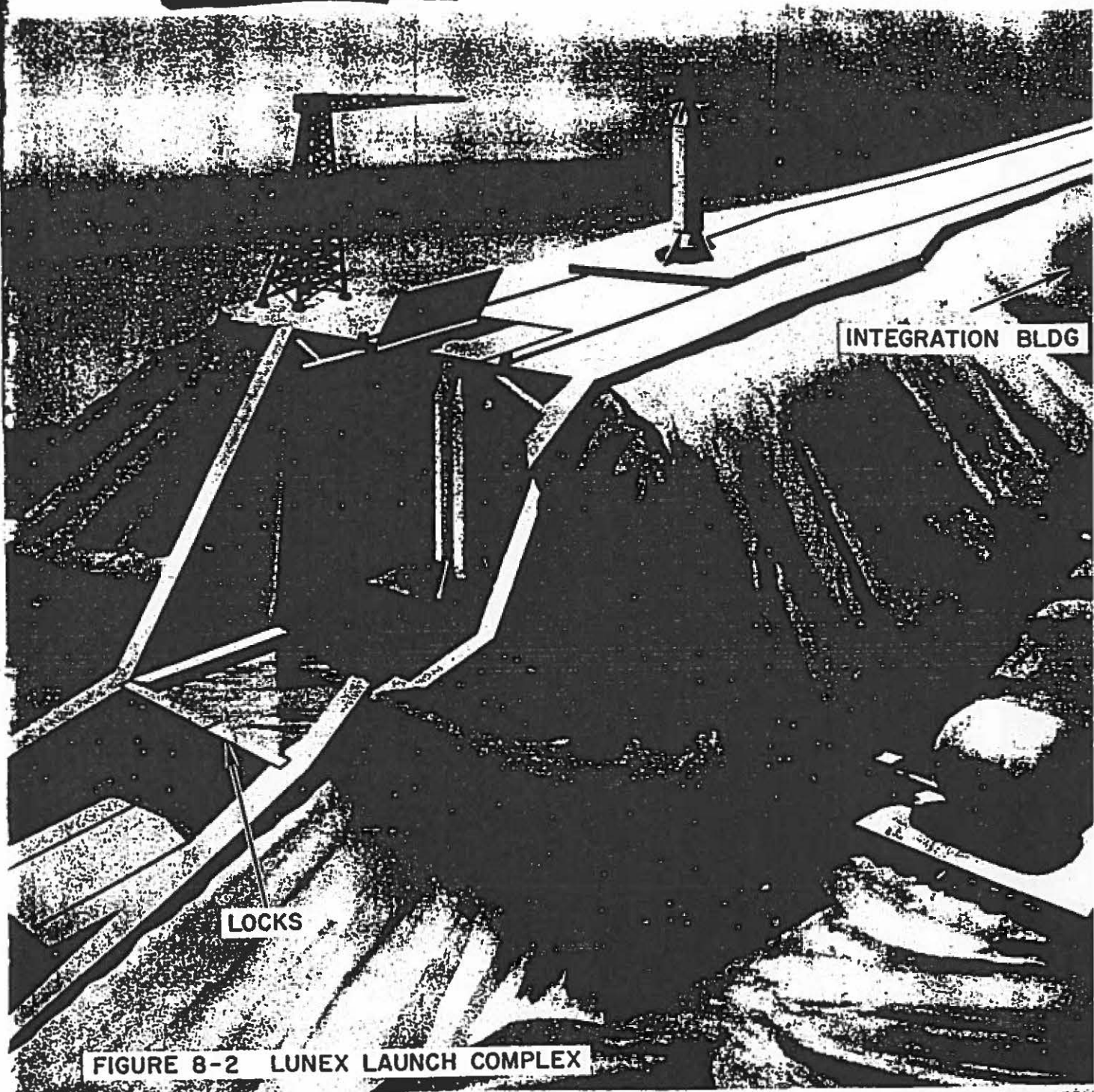


FIGURE 8-2 LUNEX LAUNCH COMPLEX

WDLAR-S-4!

[REDACTED]

is not likely to occur. This philosophy resolves to consideration of TNT equivalents of liquid propellants and solid propellants separately and they are not additive. The TNT equivalent of one of the four segmented solid assemblies is 680,000 pounds. The 60% TNT equivalent of the total liquid propellant load is approximately 1,300,000 pounds. Using the highest TNT equivalent (1,300,000 pounds) the inhabited building distance must be approximately 2½ miles from the launch pad and minimum pad separation must be approximately 1 mile. For an inhabited pad adjacent to a launch operation, pad separation would be 2½ miles. It is obvious that the real estate problem will be extensive. For a coastal location of "C" launch pads up to 18 miles of continuous coast line would be required for a distance of 3 miles inland. These distances can be decreased by creating a buffer between the pads. Locating the launch pads in ravines or indentations in cliff side launch locations might substantially reduce the land areas required. The selective location and orientation of the integration building and other support facilities to take best advantage of topography would do much to decrease distances and reduce costs.

The repeated launching of similar payloads in the Lunar Transport Launching System and the extended time between launches from each pad indicates that a central launch control for all pads might be desirable. To avoid analog signal line driving problems and to allow greater distances than normal between the pads and the common blockhouse it is possible to use digital control for launch pad checkout and launch. Analog to digital conversion would essentially be accomplished at each launch pad and transmitted to the blockhouse via digital data link. With vertical mating, assembly and detailed checkout in the vertical assembly integration buildings, only gross, survey type testing or a simulated countdown and launch would be performed at the launch pad, since test and vehicle subsystem sequencing systems could be installed in both areas. Present day checkout methods, because of the many manual controls and long-time spans involved would not provide sufficient assurance of the high reliability of the complex integrated systems expected in the Lunar Transport Vehicle.

**IX
PERSONNEL AND TRAINING**



SECTION IX

PERSONNEL AND TRAINING

**LUNAR EXPEDITION (U)
(LUNEX)**

9.1



WDLAR-S-458

[REDACTED]

RECORD OF CHANGES

CHANGE NO.	DESCRIPTION OF CHANGE	DATE OF CHANGE	REFERENCE TO BASIC PART

9.2

WDLAR-S-458

[REDACTED]

INDEX

TITLE PAGE	9.1
RECORD OF CHANGES	9.2
INDEX	9.3
9.0 INTRODUCTION.....	9.5
9.1 PERSONNEL	9.5
9.2 TRAINING PROGRAM	9.6
9.3 PLANNING FACTORS AND GROUND RULES	9.7
9.4 TRAINING.....	9.10
9.5 TRAINING PERSONNEL.....	9.11
9.6 TRAINING EQUIPMENT PACKAGE	9.11
9.7 FACILITIES.....	9.14
9.8 BUDGET AND FINANCE	9.15
ATTACHMENT	
IX - A PROJECTED MANNING AFSC'S	9.16
IX - B LUNEX/SPACE LAUNCHING SYSTEM	9.20
IX - C RE-ENTRY VEHICLE	
IX - D LUNAR LANDING STAGE	
IX - E LUNAR LAUNCH STAGE AND CARGO PAYLOAD PACKAGE	
IX - F INTEGRATED SYSTEMS	



Intentionally Blank

9.4



WDLAR-S-458

9. PERSONNEL AND TRAINING

9.0 INTRODUCTION

This section of the Lunar Expedition Program Plan (Lunex) includes estimated personnel requirements to support the program and presents the training required to accomplish the end objective.

The personnel requirements were derived on the basis of the scope of the complete program and the personnel would be comprised of civilian and military personnel.

The training program was prepared by the Air Training Command and based on the Lunar Expedition Program Plan.

9.1 PERSONNEL

The accomplishment of the Lunar Expedition Program will have a manpower impact on the Air Force that is quite different than previous programs. The number of personnel actually on the expedition will be relatively small compared to the number of personnel required to support the operation. The actual contractor "in-plant" personnel required to accomplish this program are not included in the following figures. However, a general estimate of the total contractors' effort, based on the average estimated annual expenditure for the complete Lunex program, would be the equivalent of one of our larger manufacturing companies with 60 to 70 thousand personnel. It should also be stated that this effort would undoubtedly be spread throughout the industry and not concentrated in one company and the previous statement is only for comparison.

The military and civilian personnel required to support the Lunex program is estimated as follows:

Space Personnel	145
Lunar Expedition (21 men at expedition facility, crew rates of 5)	145
Ground Personnel	3677
Lunar Squadron	100
Launch Squadron	873
Instrumentation Squadron	293
Assembly & Maintenance Squadron	860
Supply Squadron	562
Base Support Units	639
Administration	350

Total Direct Personnel (Space plus Ground)	<u>3822</u>
Overhead	<u>1287</u>
Range Tracking	940
Logistic Support Organization	347
Grand Total Personnel	<u><u>5109</u></u>

9.2 TRAINING PROGRAM

The remaining portion of this section of the Lunar Expedition Program Plan (Lunex) presents the Training Program. It is based on the limited data and information available at the time of preparation. The knowledge gained from the state-of-the art development of this program will of necessity have to be applied directly to the training areas to insure "concurrency" of the programs training development. Further, the training knowledge and experience acquired from current research and development programs must be studied for application to this program.

The concepts and plans projected in this part of the PSPP will be subject to constant revision and/or updating. Use of various simulators and synthetic training devices must be a part of the training program. Identification of the required training equipment and real property facilities to house them must be accomplished early in the program development to insure training equipment and facilities being available to meet the training need dates.

The unique mission of the Lunex program requires a comprehensive and timely source of personnel equipment data (PED). This information is required for space crew and support positions required to operate and maintain the space vehicles and support equipment. Development of such data must be initiated as part of the design effort to reduce the time element for follow-on personnel sub-system requirements.

No effort is made in this section to specify requirements for the Space Launching System since they are delineated in the Space Launching System Package Program.

This section of the Proposed System Package Program was developed under the premise that Air Training Command would be assigned the individual aerospace crew and technical training responsibilities for this program. Therefore, ATC must develop their capability concurrent with hardware development through the engineering design phases to support the expedition.



9.3 PLANNING FACTORS AND GROUND RULES

a. Scope:

This section is conceptual in nature at this time and embodies the basis for the training to be accomplished in support of the Lunar Expedition Program. It includes guidance for individual, field, unit and crew training.

b. Definitions:

(1) Aerospace Crew Personnel:

Personnel performing crew duty in the Lunar Transport Vehicle.

(2) Cadre Personnel:

Those personnel necessary for logistic planning, AFR 80-14 Testing Programs, and ATC instruction and preparation of training materials. The requirements for participation in the testing programs will include test instruments for category testing in accordance with paragraph 5 a (1) and (2), AFR 80-14, and Job Training Standards for the Integrated Systems Testing Program in accordance with paragraph 8 g (3), AFR 80-14.

(3) Main Complement Personnel:

Personnel employed in the receipt, check-out, installation, repair, maintenance and operation of the system.

(4) Support Personnel:

Air Force Logistic Command personnel required for support functions as well as other agencies' supervisors and planners.

(5) Types of Training:

(a) Type I (Contract Special Training). Special training courses conducted by contractors at an ATC installation, contractor facility or any other designated site.

(b) Type II. (ATC Special Training) Special Training Courses conducted by ATC training centers' instructors at an ATC installation, contractor facility, or any other designated site.

(c) Type III. Career training.

[REDACTED]

(d) Type IV. Special training provided by ATC training detachment instructors at the site of the organization requiring the training.

(6) Testing Programs:

(a) Component - the testing of the components of a sub-system, such as the guidance package, or ecological package.

(b) Subsystem - components assembled into a sub-system as the Re-Entry Vehicle Subsystem and tested as a unit.

(c) Integrated System - the Re-Entry Vehicle, Lunar Launching Stage and Lunar Landing Stage assembled together and tested as a whole system.

c. Assumptions:

(1) The man-rated Lunar Transport Vehicle will be available for use by the Lunar Expedition in 1968.

(2) ATC personnel will observe, participate and study the training programs developed for current research and development programs conducted under other government agencies and/or contractors.

(3) AFR 80-14 will be used as a guide for accomplishing the program testing.

(4) The terminology for normal levels of maintenance, i.e., organizational, field, depot, and shop, vehicle assembly and maintenance as specified in AFIC (AMC) letter MCM, dated 25 July 1960, subject: Standard Maintenance Terms and Maintenance Facility Nomenclature for Missile Weapon Systems will apply.

(5) The Air Force Maintenance policy of maximum maintenance at the lowest feasible level will prevail.

(6) Due to the time phasing of the subsystems, special consideration must be given to the training facilities requirements funding for the Re-Entry Vehicle technical training programs.

(7) Testing Dates:

(a) Start of Component Testing Dates are:

1. Re-Entry Vehicle - June 1963.
2. Lunar Launch Stage - February 1965.

[REDACTED]

3. Lunar Landing Stage - May 1965.

(b) Start of Subsystem Testing Dates Are:

1. Re-Entry Vehicle - November 1964.

2. Lunar Launch Stage - May 1966.

3. Lunar Landing Stage - July 1966.

d. Peculiar Requirements and/or Limitations:

(1) The unique mission of this program makes it mandatory that the following actions be accomplished concurrent with the development of the hardware:

(a) The contractors will develop the Personnel-Equipment Data information concurrent with the design of the hardware. This information must be available to ATC personnel for early planning purposes.

(b) Type I training dates reflected in the time phasing chart will require the use of R&D and test equipment as training equipment.

(c) Production schedules for R&D and Expedition equipment will include the training equipment required to support Type II and Type III training. Allocation and delivery priorities will be in accordance with AFR 67-8.

(2) An identification of personnel necessary to support this system has been made in order to assist in defining the training parameters. Changes to these estimates will be made as more conclusive information becomes available. See Charts IX A and B.

(3) Maximum Cross-Training will be provided as required to all personnel associated with this program.

(4) The requirement for follow-on training and the value of past experience is recognized and maximum retention of personnel is mandatory.

(5) New and peculiar training problems are envisioned for the technical personnel.

(6) The training of the aerospace crew personnel will require the development of a program which is unique to the Air Force.

e. Qualitative and Quantitative Personnel Requirements Information

(1) A QQPRI prepared in accordance with Mil Spec 26239A will be required to develop the training courses, course material and substantiation for the Personnel Classification changes.

(2) ATC and other applicable commands will furnish personnel for the QQPRI integration team and provide technical guidance to the contractor during preparation.

9.4 TRAINING

a. Training Responsibilities and Concepts:

(1) Engineering Design Effort

(a) ATC will participate in the engineering design effort to insure that technical data is collated with the personnel sub-system for follow-on training program requirements.

(b) ATC will be responsible for training required in support of the R&D effort under AFR 50-9.

(c) Selection of the initial aerospace crew personnel and ATC aerospace crew training instructors for the Lunar Transport Vehicle will commence 8 months prior to the start of Category I Testing.

(d) All Lunar Transport Vehicle crews and military space launching support personnel will be phased into special training (Type I), 6 months prior to Category I Testing.

(e) Environmental space training for the selected crews and instructor personnel will start 9 months prior to the start of Category II testing and will be conducted by the Aerospace Medical Center, Brooks AFB, Texas.

(f) ATC Lunar Transport Vehicle crews will be phased out of training 30 days prior to the requirement for Type II or III aerospace crew training to provide follow-on training capability in this area.

(2) Flight Testing & Expedition Program:

(a) ATC will be responsible for all individual training, i.e., technical, aerospace crew, AGE and additional job tasks as required.

[REDACTED]

(b) All requirements for Type I Special Training, AFR 50-9, in support of this effort will be contracted for by ATC.

(c) ATC will maintain liaison with the contractor concerning engineering changes in the program during its development to keep training information in consonance with the program sub-program configurations and other concepts having a direct implication to training.

(d) Flight Testing & Expedition Crew proficiency will be the responsibility of the Lunex Program Director unless ATC is requested to furnish this training.

9.5 TRAINING PERSONNEL

a. Field Training Detachment (FTD)

The number of personnel required to provide training for lunar vehicle personnel will be determined during the training programming conference. QQPRI, TPR's, Personnel Plan, Operational Plan and Maintenance Plan will be available at this time.

b. Contractor Technical Service Personnel (AFR 66-18)

Contractor technical service personnel may be initially required to augment Field Training Detachment (FTD) personnel. CTSP requirements in support of this program will be phased out as blue suit capability is achieved.

c. Trained Personnel Requirements (TPR)

TPR will be developed by commands concerned upon approval of QQPRI, and will be tabulated as gross requirements by command, by AFSC and by fiscal quarter. These requirements will be phased on anticipated need dates for personnel to be in place at the testing sites, launch sites, and maintenance areas, and will be furnished Hq ATC in sufficient time to allow proper planning for required training.

9.6 TRAINING EQUIPMENT PACKAGE

a. General:

Training equipment requirements will be developed to support:

(1) Check-out and ground maintenance to be performed by the direct support personnel for the Lunar Transport Vehicle.

[REDACTED]

(2) Flight test operations and maintenance to be performed by the responsible crews. In consideration of this, present and near future systems experience gained in the aerospace area will be applied to the Lunex program to assist in the identification of training equipment. The training for this program must be conducted in the most realistic environment practicable.

(3) Post mission maintenance and test equipment.

b. Equipment Selection:

Selection of training equipment will be based on the following general rules:

(1) Maximum utilization will be made of training equipment programmed for other missile and space system training programs.

(2) During the initial phases, equipment programmed for test, development, and the expedition programs will be used to the maximum extent practicable when regular training periods can positively be scheduled in the use of that equipment. The lack of availability of such equipment will result in degradation of training.

(3) Equipment selection will be made in consideration of future and/or subsequent programs to provide maximum training capability in similar systems with minimum cost.

(4) Maximum use and development of training films, training graphics, and synthetic training aids and devices will be made to reduce requirements for critical operational items during the initial phases of the program.

(5) Training equipment will be identified in sufficient time to enable procurement and delivery in advance of equipment for use in the flight test and expedition program.

c. Planning Factors:

Planning factors for determination of Training Equipment Requirements:

(1) In view of the limited program information presently available, definitive planning factors upon which over-all equipment requirements may be based cannot be provided. However, for preliminary planning, the following factors may be applied to subsystems of the program to determine order of

[REDACTED]

magnitude. Provided Control Centers used for other space vehicles will be applicable to the Lunar Transport Vehicle, category *I, **II, and ***III training equipment requirements as specified in USAF letter dated 30 January 1961, subject: Weapon System Training Equipment Support Policy will be as follows:

<u>Major Vehicle Sections</u>	<u>Per cent of Sub-System Cost Required for Training Items</u>
-------------------------------	--

(a) <u>Re-entry Vehicle</u>	250%
-----------------------------	------

1. Complete R/V - 1 ea
2. Sub-systems of R/V - 1 ea
3. Major components of each sub-system for Bench Items - 1 ea

(b) <u>Lunar Launch Stage</u>	150%
-------------------------------	------

1. Sub-systems of Launch Stage - 1 ea
2. 50% of Major Components for Bench Items

(c) <u>Lunar Landing Stage</u>	100%
--------------------------------	------

Major Components - 1 ea

(d) <u>Cargo Package</u>	100%
--------------------------	------

Complete Cargo Package

(e) <u>Aerospace Ground Equipment</u>	200%
---------------------------------------	------

1. Complete set for handling and testing vehicle sections and included equipment
2. Complete set as bench items for maintenance training

- * Cat I Trainers
- ** Cat II Parts/Components/End Items
- *** Cat III Training Aids/accessories

[REDACTED]

(2) Training films and transparencies requirements will be developed as soon as possible.

(3) Spare parts support will be required for all Category I and II training equipment.

(4) A continuing requirement will exist for the modification of training equipment. These modifications should be provided by review and processing of training equipment change proposals concurrent with operational equipment change proposals.

(5) Funding of P-400 money will be omitted in consonance with AFR 375-4, Para 12.

9.7 FACILITIES

a. General:

The needs for training facilities should be established approximately three years prior to the dates at which Type II training equipment will be required. Facilities must incorporate sufficient flexibility to accommodate future updating of training equipment resulting from program configuration changes.

b. Aerospace Crew Training Facilities:

(1) Initial training for aerospace crew personnel will require the use of existing space training facilities. Joint-use agreements between NASA and other USAF agencies and the Air Training Command will be required to insure maximum utilization of these facilities. Aerospace Medical Center's facilities (Brooks AFB, Texas) will be utilized to the fullest. Inter-service agreements with the Navy for use of specific training device facilities should be considered for crew training.

(2) The establishment of a centralized space training facility would have a direct bearing on the over-all specific requirements for this type of training. The results of the System Study Directive (SSD) Nr 7990-17610, titled: "Centralized Space Training Facility," will have direct bearing on the posture of the training facilities of the future. For this reason, facility requirements for follow-on training are not projected.

[REDACTED]

c. Other Training Facilities:

It is anticipated that Technical Training Centers now in existence can absorb the additional technical training load without increasing the facilities. However, modification of existing facilities to provide training laboratories with specialized power and environmental systems will be necessary. This requirement must be identified in sufficient time to permit facility programming through normal procurement cycles.

9.8 BUDGET AND FINANCE

a. Training Equipment Costs

Funding will be required for training equipment identified in Section 9.6, Training Equipment Package.

b. Training Facilities Costs

Funding and costs of training facilities will be determined once the decision is made whether to build a Centralized Space Training Facility or to continue with decentralized procedures. Funding can then be determined for the required facilities and modifications.



**CHART IX - A
PROJECTED MANNING AFSC'S
FOR LUNAR TRANSPORT VEHICLE PROGRAM**

* Proposed
** Numbers are estimates for
Type I Training Cadre

Major Segment of System	Cadre Requirement	AFSC	AFM 35-1 Title	System Association
PART A				
Vehicle Crew	1 (AFSC)	13XX	*Aerospace Flight Test Pilot	Vehicle Commander, flies vehicle, programs flight data inputs to flight regime computer.
	1 (ATC)	13XX	Aerospace Pilot	Instructor
	1 (AFSC)	15XX	*Aerospace Performance Engineer & Navigator	Deputy Vehicle Commander, navigates and maintains vehicle in flight.
	1 (ATC)	15XX		
	1 (AFSC)	30XX	*Aerospace Communications Electronics & Computer Specialist	Maintains electronic, communications and computer components. Assists in vehicle maintenance.
	1 (ATC)	30XX		
PART B				
Vehicle Support	**2 (AFSC)	30551/ 71	Electronic Digital Data Processing Repairman/ Maintenance Technician	Operates and maintains airborne computer and associated equipment.
	1 (ATC)			





CHART IX - A
PROJECTED MANNING AFSC's
FOR LUNAR TRANSPORT VEHICLE PROGRAM

* Proposed
* Numbers are estimates for
Type I Training Cadre

Major Segment of System	Cadre Requirement	AFSC	AFM 35-1 Title	System Association
PART A				
Vehicle Crew	1 (AFSC)	13XX	*Aerospace Flight Test Pilot	Vehicle Commander, flies vehicle, programs flight data inputs to flight regime computer.
	1 (ATC)	13XX	Aerospace Pilot	Instructor
	1 (AFSC)	15XX	*Aerospace Performance Engineer & Navigator	Deputy Vehicle Commander, navigates and maintains vehicle in flight.
	1 (ATC)	15XX		
	1 (AFSC)	30XX	*Aerospace Communications Electronics & Computer Specialist	Maintains electronic, communications and computer components. Assists in vehicle maintenance.
	1 (ATC)	30XX		
PART B				
Vehicle Support	**2 (AFSC)	30551/71	Electronic Digital Data Processing Repairman/Maintenance Technician	Operates and maintains airborne computer and associated equipment.
	1 (ATC)			

9.16

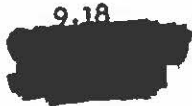
WDLAR-S-458



Major Segment of System	Cadre Requirement	AFSC	AFM 35-1 Title	System Association
Vehicle Support (Continued)	2 (AFSC)	29373	Airborne Radio and Electronic Countermeasure Operator Technician	Operates and Repairs radio and radio Elint equipment.
	1 (ATC)			
	2 (AFSC)	42250/70	Instrument Repairman/Technician	Vehicle Instruments.
	2 (AFSC)	42251/71	Mechanical Accessories and Equipment Repairman/Technician	Maintenance of mechanical accessories.
	1 (ATC)			
	2 (AFSC)	30151/71	Aircraft Electronic Navigation Equipment Repairman/Maintenance Technician	Maintain electronic navigation equipment.
	1 (ATC)			
	1 (AFSC)	30150/70	Aircraft Radio Repairman/Maintenance Tech.	SHF, UHF data link equipment.
	1 (AFSC)	30153/73	Aircraft Electronic Countermeasures/Maintenance Technician	Repair Airborne Electronic Elint equipment.
	1 (AFSC)	46250/70	Weapons Mechanic/Maintenance Supervisor	Capsule ejection system and loading



or Segment System	Cadre Requirement	AFSC	AFM 35-1 Title	System Association
cle Support (continued)	1 (AFSC)	56850/70	Liquid Fuel Systems Maintenance Specialist/Technician	Liquid Air System and fuel systems.
	1 (ATC)			
	2 (AFSC)	53450/70	Airframe Repairman/Technician	Airframe including nose cone.
	1 (ATC)			
	2 (AFSC)	42152/72	Aircraft and Missile Pneudraulic Repairman/Technician	Repairs Hydraulic and Pneumatic Systems.
	1 (ATC)			
	2 (AFSC)	42353/73	Flight Control/Auto Pilot Systems Repairman/Technician	Checks out and repairs auto pilot system.
	2 (AFSC)	31150/70	Guidance Systems Mechanic/Technician	Maintains and repairs vehicles guidance systems/infra-red detections and associated equipment.
	1 (ATC)			
	2 (AFSC)	31250/70	Control Systems Mechanic/Technician	Maintains and repairs vehicles control systems.
	1 (ATC)			
	2 (AFSC)	00370	Abort System Vehicle Technician	Maintains and repairs vehicles abort system.



Major Segment of System	Cadre Requirement	AFSC	AFM 35-1 Title	System Association
Vehicle Support (Continued)	2 (AFSC)	43351/71	Missile Engine Mechanic/Technician	Propulsion system and retro rockets.
	1 (ATC)			
	2 (AFSC)	42350/70	Aircraft and Missile Electrical Repairman/Technician	Electrical System
	1 (AFSC)	56650/70	Refrigeration Specialist/Supervisor	Maintain refrigeration and ventilation equipment.
	1 (AFSC)	30152/72	Aircraft Early Warning Radar Maintenance Repairman/Technician	Radar Doppler Navigation Equipment.
	1 (ATC)			
	2 (AFSC)	27250/70	Air Traffic Control Operator/Technician	Operates acquisition and precision approach radar.
	1 (AFSC)	30551/71	Electronic Digital Data Processing Repairman Operator/Technician	Insures proper operation and repair of approach computer.
	1 (ATC)			
	Additional Specialist		62271	Diet Supervisor
		90150/70	Aeromedical Specialist/Technician	Sub-professional tasks for physical exams and treatment.
		58250/70	Fabric, Leather and Rubber Products Repairman/Repair Supervisor	
		92250/70	Personal Equipment Specialist/Supervisor	

[REDACTED]

CHART IX - B

LUNEX/SPACE LAUNCHING SYSTEM

1. The estimates for the launch system are not included in view of the status of the Space Launching System (SLS) study. It can, however, be estimated that the launch complex personnel utilized in both the liquid/solid propellant type boosters will be integrated into a team for support of this system.
2. At such time as the S.L.S. is designated as the primary launch support system, a PSPP will be made for the launch vehicle and support AFSC's as a part of this program.

9.20

[REDACTED]

WDLAR-S-458

[REDACTED]

CHART IX - B

LJNEX/SPACE LAUNCHING SYSTEM

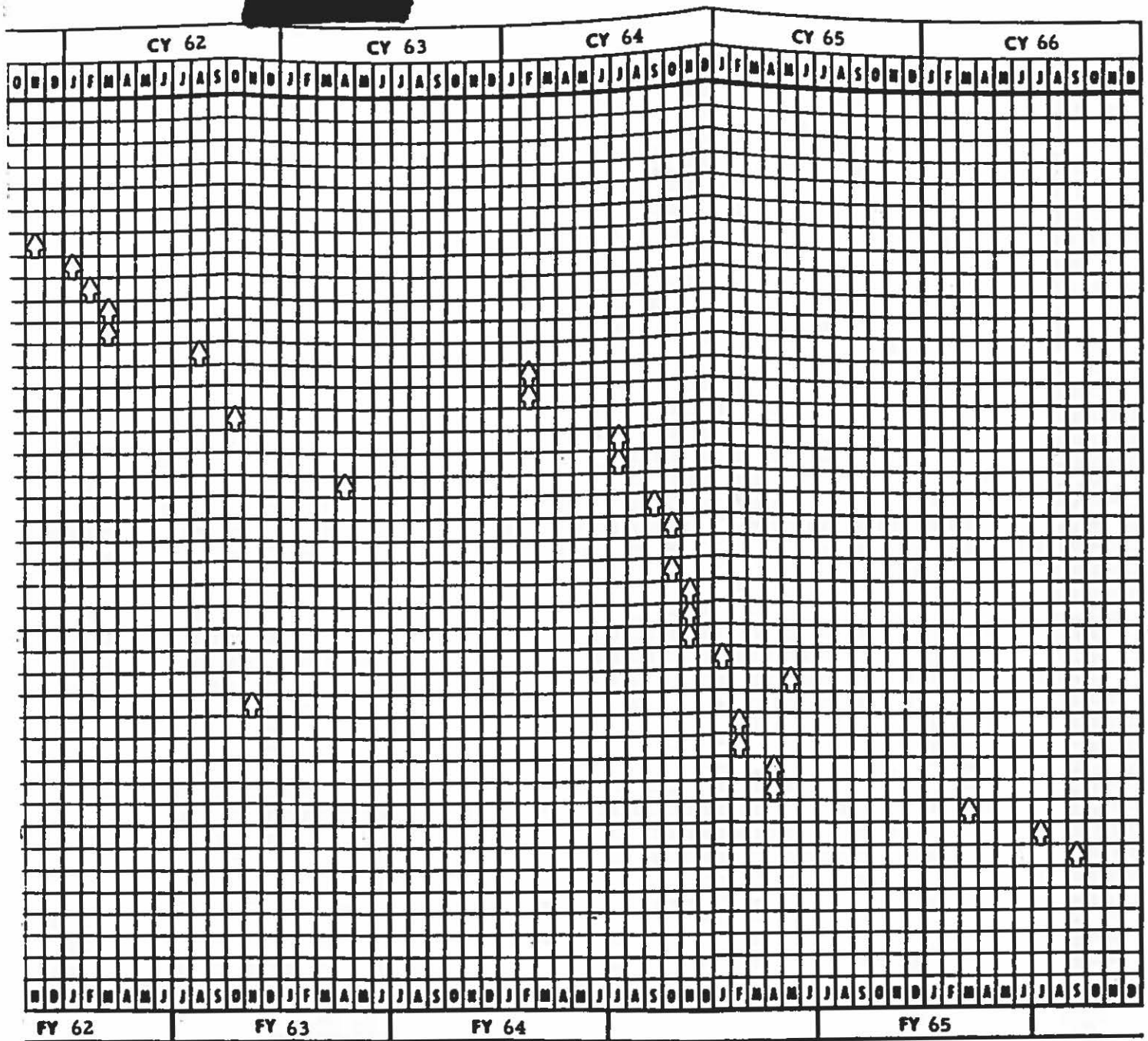
1. The estimates for the launch system are not included in view of the status of the Space Launching System (SLS) study. It can, however, be estimated that the launch complex personnel utilized in both the liquid/solid propellant type boosters will be integrated into a team for support of this system.
2. At such time as the S.L.S. is designated as the primary launch support system, a PSPP will be made for the launch vehicle and support AFSC's as a part of this program.

9.20

[REDACTED]

WDLAR-S-458

[Redacted]



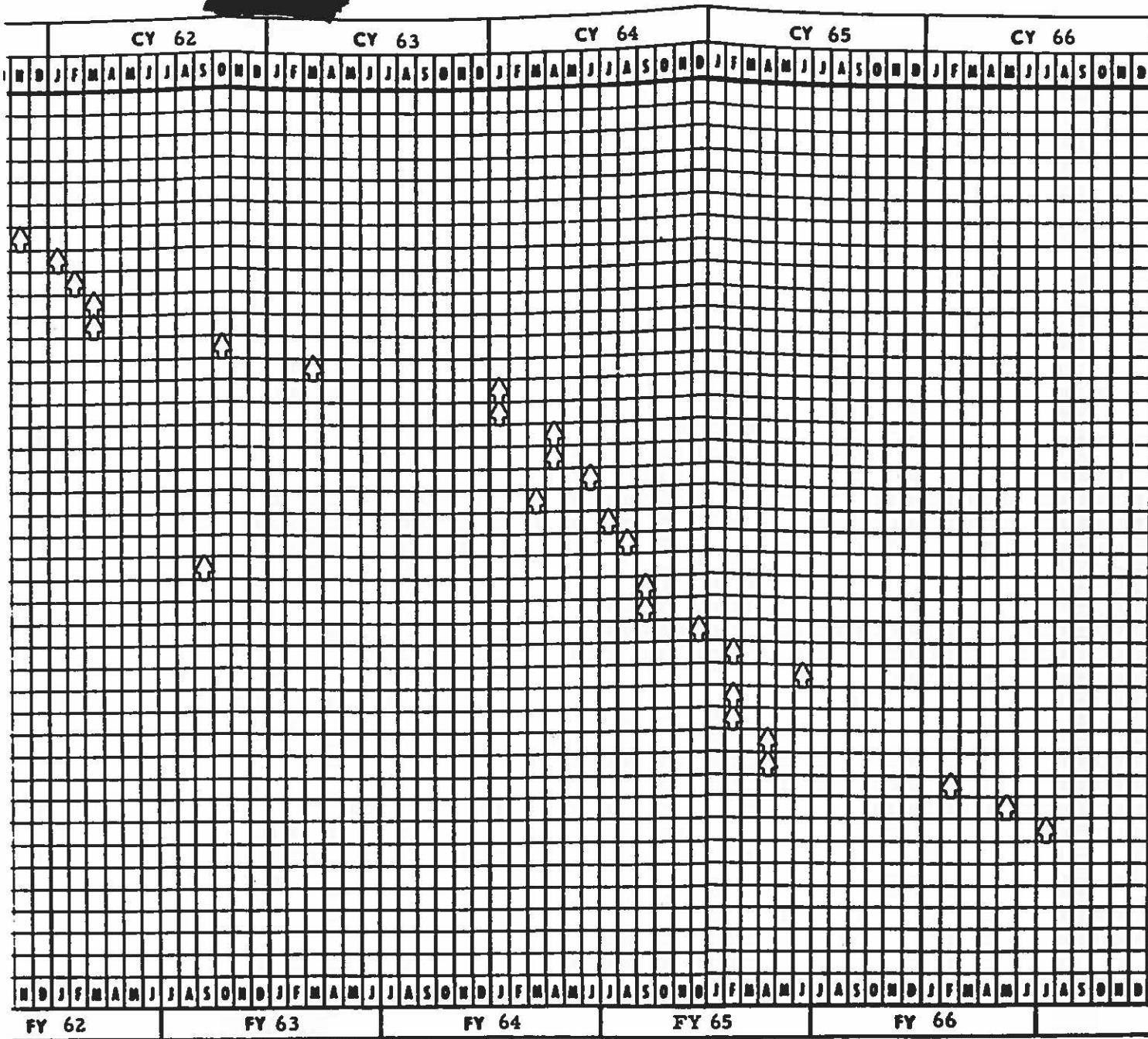
FY 62

FY 63

FY 64

FY 65

[Redacted]



PROGRAM SCHEDULE



	INTEGRATED SYSTEM																																			
	FY 66						FY 67																													
	CY 65						CY 66						CY 67																							
	J	F	M	A	M	J	J	A	S	O	N	D	J	F	M	A	M	J	J	A	S	O	N	D	J	F	M	A	M	J	J	A	S	O	N	D
1. System QQPRI Integrated												↑																								
2. System TEPI Integrated												↑																								
3. System QQPRI Reviewed																		↑																		
4. System QQPRI Approved																		↑																		
5. System TEPI Received																		↑																		
6. TPR Prepared and Distributed																		↑																		
7. Training Program Conference																																				
8. Lunar Launch and Return (System Test)																																				
9. Training Support Conference																																				
10. Training Equipment in Place																																				
11. Training Materials Ready																																				
12. Type III Training Starts																																				
13. Lunar Expedition																																				
14.																																				
15.																																				
16.																																				
17.																																				
18.																																				
19.																																				
20.																																				
21.																																				
22.																																				
23.																																				
24.																																				
25.																																				
26.																																				
27.																																				
28.																																				
29.																																				
30.																																				
31.																																				
32.																																				
33.																																				
34.																																				
35.																																				
36.																																				
37.																																				
38.																																				
39.																																				
40.																																				





RELATED SYSTEM	FY 66												FY 67												FY 68												
	CY 65						CY 66						CY 67						CY 68																		
	J	F	M	A	M	J	J	A	S	O	N	D	J	F	M	A	M	J	J	A	S	O	N	D	J	F	M	A	M	J	J	A	S	O	N	D	
Integrated																																					1
Integrated																																					2
Reviewed																																					3
Approved																																					4
Received																																					5
and Distributed																																					6
in Conference																																					7
and Return (System Test)																																					8
Conference																																					9
ent In Place																																					10
als Ready																																					11
z Starts																																					12
																																					13
																																					14
																																					15
																																					16
																																					17
																																					18
																																					19
																																					20
																																					21
																																					22
																																					23
																																					24
																																					25
																																					26
																																					27
																																					28
																																					29
																																					30
																																					31
																																					32
																																					33
																																					34
																																					35
																																					36
																																					37
																																					38
																																					39
																																					40



X
INTELLIGENCE

[REDACTED]

SECTION X

INTELLIGENCE ESTIMATE

LUNAR EXPEDITION (U)
(LUNEX)

10.1

WDLAR-S-458

[REDACTED]

RECORD OF CHANGES

CHANGE NO.	DESCRIPTION OF CHANGE	DATE OF CHANGE	REFERENCE TO BASIC PART

10.2

WDLAR-S-458



INDEX

TITLE PAGE 10.1
RECORD OF CHANGES. 10.2
INDEX. 10.3
10.0 INTRODUCTION 10.5
10.1 FOREWORD 10.5
10.2 PERFORMANCE CAPABILITY 10.5
10.3 SUMMARY AND CONCLUSIONS. 10.6





This page intentionally left blank

10.4

WDLAR-S-458



[REDACTED]

10. INTELLIGENCE ESTIMATES

10.0 INTRODUCTION

The purpose of this section of the program plan is to estimate the foreign threat in terms of technical capabilities and probable programs which may affect the establishment of a lunar expedition. The threat will be defined in terms of major performance capability and dates of operational availability.

10.1 FOREWORD

The following data was obtained from DCS/Intelligence, Hq ARDC and published Intelligence estimates.

10.2 PERFORMANCE CAPABILITY

The Soviets have flown geophysical and component equipment payloads on their vertical rockets for the development, modification, and acceptance testing of instrumentation for use on their satellite and lunar aircraft. They developed and used complex scientific instrumentation on Sputnik III, and stabilization, orientation and control equipment on Lunik III and Sputnik IV. Presently, by using their vertical rockets, the Soviets are testing infrared equipment, in addition to collecting data on the background noise level of the earth's surface. It is believed that a development program exists which eventually could lead to detection and reconnaissance satellites. The development program which led to the photographic system used in Lunik III is expected to continue, with an eventual application in photographic reconnaissance and weather satellites.

The Soviet space launch capability is shown in the following table of Sputrik and Lunik booster thrust levels:

Sputnik I	300,000 pounds
Sputnik II	300,000 pounds
Sputnik III	432,000 pounds
Lunik I, II, and III	456,000 pounds
Lunik IV, V, and VI	466,600 pounds

There is also evidence of a cluster of five 140,000 pound units. The Soviets are developing engines of 1 to 2½ million

[REDACTED]

pound thrust. The estimated time for a booster to match this engine is as follows:

Single engine booster - 1963

Clustered engine booster - 1965

In general, it takes approximately half the time for development required in the U.S.

The maximum Soviet orbit capability, with present ICBM boosters using five (140,000 pound thrust) engines and four (6,600 pound thrust) engines is 10,000 pounds in low altitude orbit. All Lunik and Sputnik vehicles utilized a third stage having 12,500 pound thrust engine burning for approximately 420 seconds.

By using higher energy chemical propellants in modified upper stages, the payload can be increased up to 15,000 or 20,000 pounds during 1961. However, approximately 50,000 pounds of payload may be attained by 1962 if ICBM launch vehicle thrust is increased.

In the 1965-1970 period, a new clustered chemical booster should allow the Soviets to place 50 to 100 tons in orbit on individual launches. This will permit landing a man on the moon.

10.3 SUMMARY AND CONCLUSIONS

Very early the Soviets realized the propaganda value obtainable from space adventures and, accordingly, have striven continuously for "firsts". This has apparently influenced the detailed pattern for their space planning. Even though the Soviets have achieved "firsts" in:

- 1) Establishment of an artificial earth satellite
- 2) Rocketing past the moon and placing a vehicle into a solar orbit
- 3) Hard impact on the moon
- 4) Photographing the side of the moon not visible from the earth
- 5) Safely returning mammals and men from orbit

It seems obvious that the Soviet attempts to score "firsts" will continue.

[REDACTED]

Although large orbiting spacecraft appear to be the prime Soviet technical objective during the period of this estimate, it is believed they will continue to use and improve their current lunar probe capability since there are many "firsts" yet to be accomplished in the exploration of the moon. These include lunar satellites, lunar soft landings, lunar soft landings and return with actual samples of the lunar surface, and, finally, a tankette for a true lunar exploration.

It is expected that the Soviets will continue to launch unmanned lunar rocket probes for the purpose of reconnoitering the moon and near moon environment for the application of this knowledge to the development of manned lunar exploration systems.

Since soft landings are essential for obtaining data on the lunar surface, it is believed that the Soviets definitely will have to develop techniques for achieving lunar soft landings, especially soft landings and return to earth, to establish the procedures to be employed in accomplishing the main objective of establishing a manned lunar station. The first of these test vehicles could be very similar to their Arctic automatic weather stations that presently are jettisoned from aircraft. This vehicle would be able to record temperature, micro-meteorite impact, various types of radiation, particle concentration, seismic disturbances, solid resistivity, and depth of probe penetration. As landing techniques are improved, larger payloads with increased instrumentation for terminal control and lunar re-start and launch capabilities will undoubtedly be developed.

Circumlunar flights by manned space vehicles, and eventually lunar landings, will be required in order to know more precisely the environmental situation preliminary to the eventual establishment of a lunar base and the complete conquest of this body. This is considered to be a more distant objective of the Soviet program and its attainment will appear, if at all during this decade, toward the end of the period.

Although the landing of a "tankette" on the moon falls under the category of a soft landing, the size and weight of such a vehicle makes it a sufficiently worthy subject for special consideration. The Soviets have published extensively on such a vehicle, and Yu D. Khelbtovich, Chairman of the Science Technical Committee for Radio Remote Control of Cosmic Rockets, has published his preliminary design of a tankette laboratory for lunar exploration. Graduate students of Moscow High Technical School now are experimenting with models of a tankette in layers of powdered cement to simulate powdered soil conditions which might be expected on the moon.

[REDACTED]

Actual accomplishment of the project will have to await the availability and flight testing of the new booster with thrust in the millions of pounds category in the 1965 time period.

The Soviets do not differentiate between military and non-military space systems. They have talked of a peaceful intent of their space program but there are many pounds of payload in their satellites which cannot be accounted for on the basis of data given out. It should be presumed that this could be military payloads. With this in mind, it can be stated that during the early 1970's it is possible that space weapon systems will be developed as a supplement to earth-based delivery systems. It is also possible that military facilities may have been established on or in orbit around the moon. Atmospheric and climatic conditions will demand an air conditioned environment for moon-based delivery systems. For increased survival security and decreased requirements for "imported" construction material, it seems reasonable to assume that these would be constructed under rather than above the moon's surface.



GLOSSARY OF TERMS

The Lunar Expedition Program, like any major program or technical discipline, has developed special terminology to better describe the problem areas, techniques, equipments, environmental conditions, and objectives associated with the program.

This glossary presents the definitions for the special terms used in the LUNEX program, as well as the standard terms and established program titles used in this document.

Figure A-1, Lunar Transport Vehicle, is used to illustrate the definitions where referenced.

LUNAR PROGRAM TERMINOLOGY

Boosters

Boosters represent the capability of lifting a vehicle on a desired trajectory. The Space Launching System uses the following "boosters":

- "A" - Designation of a booster with a single J-2 engine using LOX/LH₂ and having a thrust of 200,000 pounds vacuum.
- "B" - Designation of a LOX/LH₂ booster having an initial weight of 480,000 pounds and a vacuum thrust of 800,000 pounds.
- "C" - Designation of a LOX/LH₂ booster having an initial weight of approximately 1,800,000 pounds and a thrust of 3,000,000 pounds vacuum.

Solids - Solids are designated by numbers as follows:
"410" where it represents a solid booster weighing 410,000 pounds.

For larger payload requirements the Space Launching System designates booster systems in the following manner:

- "AB410" - Where the first firing stage is a 410,000 pound solid booster, the second firing stage is a B booster and the third firing stage is an A booster.

[REDACTED]

Cargo Package

The Lunar Cargo Package: (See Figure A-1, item e) is that part of the Cargo Payload which represents a package consisting of supplies, equipment, etc., needed on the lunar surface. Preliminary design data indicates that an amount in excess of 40,000 pounds must and can be delivered to the lunar surface.

Cargo Payload

The Cargo Payload is that part of the Lunar Transport Vehicle which is placed on a selected lunar trajectory and is boosted to earth escape velocity. It consists of two major parts. These are:

Lunar Landing Stage

Cargo Package

This division is schematically represented in Figure A-1 by the parts labelled b and c. The cargo payload does not include a Lunar Launch Stage since the cargo package remains on the lunar surface. The weight of the Cargo Package is equivalent to the combined weight of the Lunex Re-entry Vehicle (3 men) and the Lunar Launch Stage. The Cargo Payload weighs 134,000 pounds at earth escape.

Circumlunar

A highly elliptical trajectory that goes around the moon and returns to the earth.

Circumlunar Propulsion Stage

A stage attached to the Lunex Re-entry Vehicle to provide a suitable propulsion and control capability for maintaining the Re-entry Vehicle on a circumlunar trajectory.

Delayed Procurement Concept

Concept of deferring the final ordering and production of high-cost insurance type spares until maximum flight experience is available.

High-Speed Re-entry Test

A test program using a special Re-entry Test Vehicle designed to obtain fundamental re-entry data and specific configuration data at re-entry velocities of 25 to 45 thousand feet per second.

A1.2

[REDACTED]

WDIAR-3-458

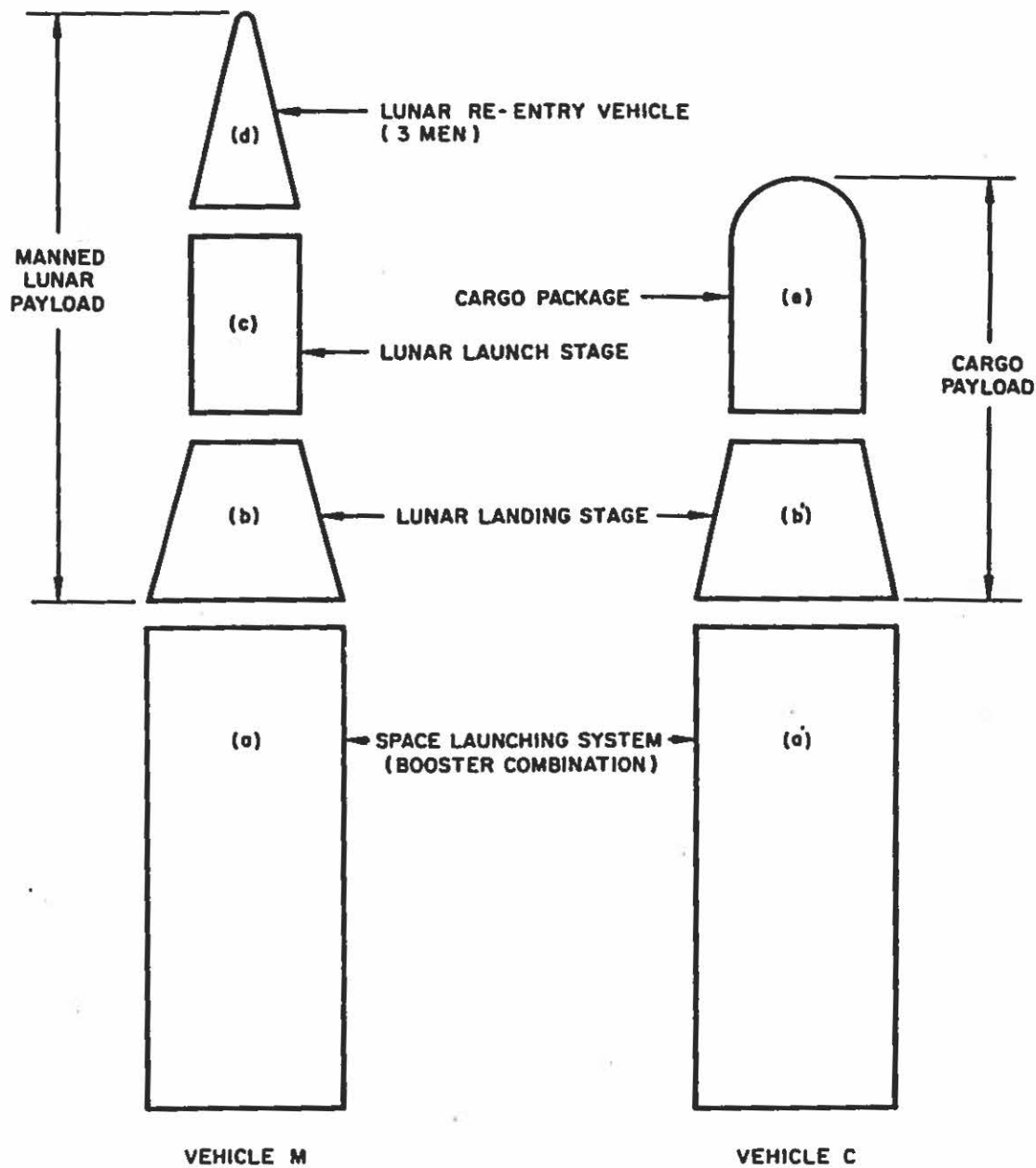


FIGURE A-1 LUNAR TRANSPORT VEHICLE



Lunar Expedition Facility

A facility designed to be constructed under the lunar surface and to support the Lunar Expedition. This facility will be designed so that it can be readily expanded to support future military requirements

Lunar Landing Stage

The Lunar Landing Stage is that part of the Manned Lunar Payload that will land the Manned Lunar Payload at a selected site on the surface of the moon. The expended portion of this stage is left on the lunar surface when the Lunex Re-entry Vehicle is launched for the return trip to earth (See Figure A-1, item b.).

Lunar Landing Stage - Cargo

The Lunar Landing Stage of the Cargo Payload (See Figure A-1, item b') is identical to the landing stage of the manned Lunar Payload. It provide the capability of soft landing the Cargo Package at a preselected site. The Cargo Payload is unmanned and the landing operation is automatic. The Lunar Landing Stage remains on the lunar surface with the Cargo Payload.

Lunar Launch Complex

The Lunar Launch Complex consists of the base facilities, integration buildings, check-out buildings, launch pads, propellant manufacturing plants, the complex control center and all of the equipment required to earth launch and support the Lunar Expedition.

Lunar Launching Stage

The Lunar Launch Stage (See Figure A-1, item c) is that part of the Manned Lunar Payload that will boost the Lunex Re-entry Vehicle to lunar escape velocity on a moon-to-earth trajectory. It will be ejected prior to earth re-entry.

Lunar Team

The Lunar Team consists of Air Force technical personnel from various Air Force System Command organizations and the various Air Force Command organizations. This team was formed to assist the SSD in establishing a sound Lunar Expedition program. The membership during the past two years has varied from 30 to 50 personnel:

Lunar Transport Vehicle

The Lunar Transport Vehicle is required to transport men and materials for the Lunar Expedition. The Lunar Transport Vehicle

[REDACTED]

consists of a Space Launching Vehicle and one of two payloads. One payload is the Manned Lunar Payload and the other is the Cargo Payload (See Figure A-1)

LUNEX

LUNEX is a short title for the Lunar Expedition Program

Lunex Program Director

The Lunex Program Director is the individual responsible for directing and controlling all facets of the Lunar Expedition Program.

Lunex Re-entry Vehicle

The Lunex Re-entry Vehicle (See Figure A-1, item d) is the only part of the Manned Lunar Payload that returns to the earth. It carries three men and all the necessary life support, guidance, and communication equipment that is required. It re-enters the earth's atmosphere and uses aerodynamic braking to slow down and land like a conventional airplane. The preliminary design of the Lunex Re-entry Vehicle calls for a vehicle 52 ft. long with a return weight of 20,000 pounds.

Man-rated

A vehicle, or system is considered to be "man-rated" when sufficient ground and flight test data has been accumulated to determine that the reliability objectives for the item have been achieved and that the abort system satisfactorily compensates for the inherent unreliability of the system.

Manned Lunar Payload

The Manned Lunar Payload is that part of the Lunar Transport vehicle which is placed on a selected lunar trajectory and is boosted to an earth escape velocity of approximately 37,000 feet per second. It consists of three major parts. These are:

Lunar Landing Stage

Lunar Launch Stage

Lunex Re-entry Vehicle (3 men)

This division is schematically represented in Figure A-1 by the parts labelled b, c, and d. The complete Manned Lunar Payload weighs 134,000 pounds at earth escape.

[REDACTED]

Responsive Production Concept

A concept whereby long lead portions of high-cost operational spares are purchased unassembled to reduce costs until final decision is made on spares procurement.

Space Launching System

The complete system, including ground facilities, propellant manufacturing facilities, etc., as required to launch the boosters required for space operations.

STANDARD TERMINOLOGY

AGE

A term used to describe the Aerospace Ground Environment required for a specified system.

Abort System

The Abort System includes all the equipment required to remove, or return the crew members of the Lunex Re-entry Vehicle to a position of safety in the event of a malfunction of the Lunar Transport Vehicle.

PEP

P.E.P. are the initials for "Program Evaluation Procedure". It is a management tool which uses an electronic digital computer. It has the capacity to handle large masses of data quickly. The PEP system provides information that will enable the Lunex Program Director to quickly identify, locate, and consequently, correct program trouble spots.

QQPRI

A term used to describe Qualitative and Quantitative Personnel Requirements Information that is required to properly plan for personnel training.

RFIF

A term meaning Real Property Installed Equipment that is synonymous with Technical Facilities. Technical Facilities are those structural and related items which are built and/or installed by the Corps of Engineers and then turned over to the Air Force or an Air Force contractor.

[REDACTED]

USAF Lunar Chart

A chart prepared to a scale of 1:1,000,000 and covering the lunar surface. Present plans call for the preparation of 144 individual charts to cover the complete lunar surface.

PROGRAM TITLES:

BOSS

BOSS is the designation for "Biomedical Orbiting Satellite System". The BOSS program uses primates to provide life science data for designing manned space systems.

SAINT

The SAINT program will develop and demonstrate orbital rendezvous and satellite inspection techniques. It will further demonstrate the capability of closing, docking, and refueling.

